



CONNECT AND PROTECT

nVent ERICO Cadweld Welded Electrical Connections

nVent ERICO Cadweld Plus

THE STANDARD BY WHICH ALL OTHERS ARE MEASURED



Cadweld Plus is a revolutionary system that simplifies the process for exothermically welded connections.

Reliable – Cadweld connections consistently perform the best in independent IEEE® 837 tests.

Innovative – Cadweld Plus offers easy ignition and increases flexibility in hard-to-reach areas.

Easy to Use – Cadweld Plus connections require fewer parts, no starting material and no cumbersome tools.

Most Experienced – nVent ERICO, the recognized leader in grounding and bonding.

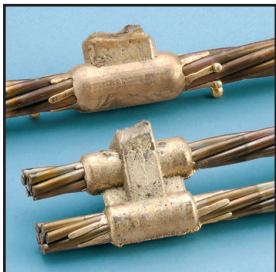

Cadweld Plus is the ultimate exothermic welded connection



Space-saving packaging ships and stores easily

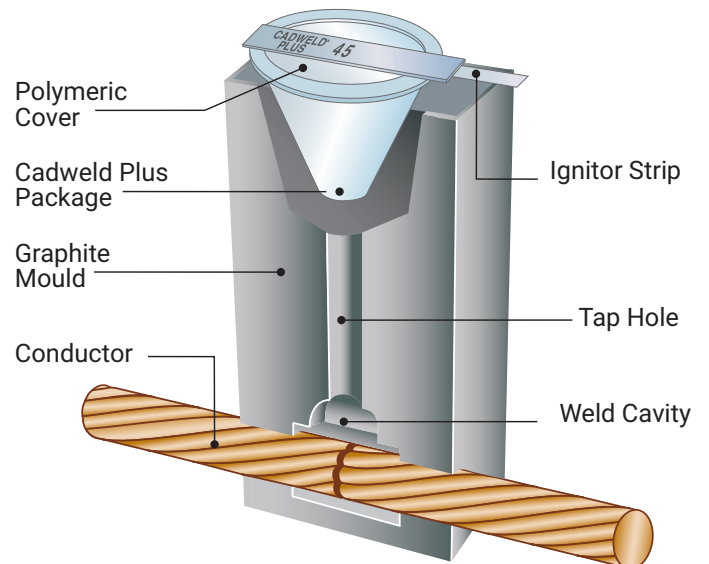

TABLE OF CONTENTS

Ordering Information	1	Ground Rod Splice – GB	31
The Cadweld Mould Numbering System	2-3	Cable to Rebar – RR	32
Metric to Imperial Conversion Chart	4	Cable to Rebar – RD	33
Cadweld– Technical Advantages	5-6	Cable/Busbar Tape to Rebar – RJ	34
Technical Information	7	Cadweld Cast Ground Plates	35
Cadweld Plus	8	Aircraft Grounding Receptacles	36
Cadweld Multi	9-10	Other Cable to Cable Connections	37
Horizontal Connection – SS	11	Other Cable to Ground Rods or Other Connections	38
Horizontal Tee – TA	12	Other Cable to Steel or Cast Iron Connections	39
Horizontal X – XA/XB	13	Other Cable to Busbar or Lug Connections	40
Parallel Horizontal – PT	14	Other Busbar to Busbar Connections	41
Horizontal Steel Surface – HA/HS	15	Other Busbar Connections	42
Vertical Steel Surface – VS	16	Other Rebar Connections	42
Studs – HX/HV	17	Cable to Copper Tube Connections	43
Busbar Tape – BA/BB	18	Busbar to Ground Rods Connections	43
Busbar Tape – BM/BQ	19	Copper Tube to Ground Rods Connections	44
Cable to Busbar Tape – LE	20	Copper Tube to Copper Tube Connections	44
Busbar Tape – EB	21	Copper Tube to Busbar or Lugs Connections	44
Busbar Tape – BW/CG	22	Material, Tools and Accessories	
Cable to Busbar Tape – LJ	23	Adapting Moulds to Fit Conductors	45
Copper Lugs – LA	24	Cable and Work Surface Preparation	46
Copper Lugs – GL	25	Mould Care and Use	47
Cable to Ground Rod – GR	26	Mould Fastening and Mounting	48-49
Cable to Ground Rod – GT	27	Ground Rod Specialty Tools	50
Cable/Tape to Ground Rod – GY/LQ	28	Other Tools	50-51
Tape to Ground Rod – CP/CN	29	Tool Kits / Tool Tray	51
Cable to Ground Rod		Reference Material	52
Cadweld One Shot – GR/GT	30		

HOW TO ORDER CADWELD PRODUCTS

This catalog lists popular Cadweld connections. Look in the index for the connection you need. If you cannot find the connection you need, contact nVent or your local distributor or agent. Only the most popular Cadweld connections are listed in this catalog. We have designed over 45,000 connections and “specials” are designed every day.

1. WHAT CONNECTION DO YOU REQUIRE?

Available connections are listed in the pictorial index which also shows the degree of difficulty in making the connection, and ease of mould cleaning. We strongly recommend that wherever possible you use moulds listed in this catalog. After selecting the connection, turn to the appropriate page and select the mould, welding material and tools you need.

2. WHAT ARE THE CONDUCTOR SIZES?

This catalog covers connections between solid or concentric stranded copper conductors, and busbars to each other, to lugs, to ground rods, to rebar, to rail and to special grounding accessories. For sizes not listed, contact your local Cadweld distributor, agent, or nVent.

Note: Other publications describe connections to conductors of copperclad, high voltage copper, aluminium, busbar, lightning protection cable, steel cable, etc.

3. YOU MUST HAVE THE FOLLOWING TO MAKE A WELD:

1. Mould to fit your conductors.
2. Welding material required by your mould.
3. Handle clamps or frame.
4. Cadweld Plus Control Unit or Flint Ignitor.
5. Lugs, sleeves, packing material listed on the page with the mould.

The Cadweld Mould Numbering System

The Cadweld Mould Part Number gives, in code, the complete information of the mould
 – type of connection, mould price key, and conductor size(s).

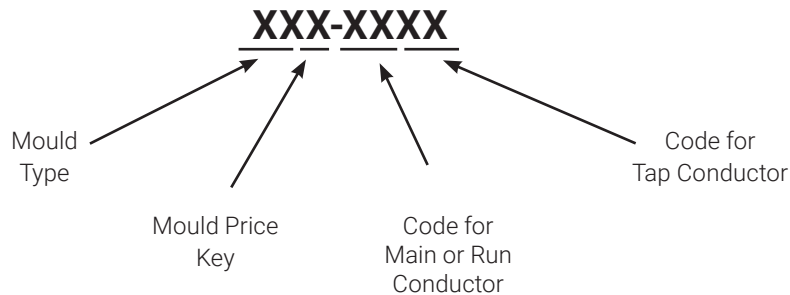

EXAMPLES

TAC-Y6Y4

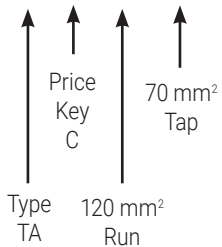

GTC-P143Y6

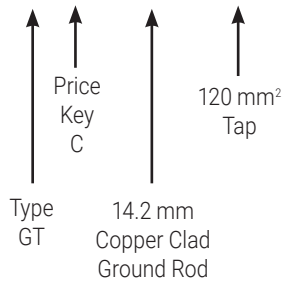

SSC-Y4

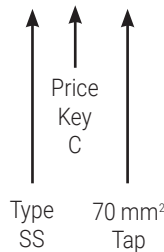

VSC-Y2-V76

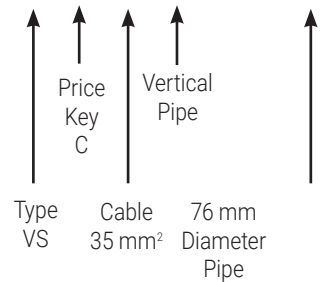

CERTAIN TOOLS MAY BE REQUIRED FOR VARIOUS CONNECTIONS.

If required, these tools are listed on the same page as the connection and in Section A.

- Some tools listed in Section A can save you a lot of time.
- Also refer to A9E, Contractor Tips, to make your job easier, and learn about labor saving ideas.

For other Cadweld literature, videos and software, visit nVent.com/ERICO

REQUIRED TOOLS SUMMARY

Required tools are listed with each mould. For your reference, handle clamps and/or frame are summarized below.

MOULD	REQUIRED
A*	Includes frame with handle
C, Q & R	Requires L160
D, F & Z	Requires L159
E*	Includes frame but also requires L160
J*	Includes frame but also requires L159
K*, M* & V*	Includes frame with handles

* To order mould only - without handles or frame - add suffix "M" to mould part number.

The Cadweld Mould Numbering System

COMMON REFERENCE FOR CABLE DIAMETERS

Concentric Cable			
Nominal Area (mm ²)	Strand	Diameter Range (mm)	Cable Size Code
6	7/1.07	3,21	A7
10	7/1.37	4,12	W2
16	7/1.73	5,18	W3
25	7/2.16	6,48	Y1
25	19/1.32	6,60	Y1
35	7/2.54	7,62	Y2
35	19/1.55	7,75	Y2
50	19/1.85	9,27	Y3
70	19/2.18	10,90	Y4
95	19/2.57	12,80	Y5
95	37/1.83	12,80	Y5
120	37/2.03	14,21	Y6
120	19/2.84	14,20	Y6
150	37/2.29	16,00	Y7
185	37/2.54	19,80	Y8
240	37/2.90	20,30	Y9
300	61/2.51	22,60	Y0

For other cable sizes or different stranding, please contact your local Cadweld distributor, agent or nVent.

BUSBAR / TAPE KEY

Thickness (mm)	CADWELD Code	Width (mm)	CADWELD Code
2	BA	20	H
3	CA	25	J
3,5	DA	30	K
4	EA	35	V
5	FA	40	L
6	PA	50	M
8	GA	60	N
10	HA	80	P
		100	Q

GROUND RODS

Size	CADWELD Code
7 mm	P070
10 mm	P100
12.7 mm	P128
14 mm	P140
14.2 mm	P143
15 mm	P150
16 mm	P160
17.2 mm	P172
19 mm	P190
20 mm	P200

REBAR

Size	CADWELD Code
10 mm	51
12 mm	52
16 mm	53
20 mm	92
22 mm	55
25 mm	56
32 mm	58
36 mm	59
40 mm	83

Metric to Imperial Conversion Chart

METRIC CABLES				US EQUIVALENT			
Area Cross sectional area mm ² (SQMM)	Metric Cable Code	Diameter		AWG/MCM Size	AWG/MCM Cable Code	Diameter	
		mm	Inch			Inch	mm
2.0 Concentric	-	1.8	0.071	#14 Concentric	-	0.0726	1.84
3.5 Concentric	G8	2.4	0.095	#12 Concentric	-	0.0915	2.3
w/B1331H sleeve (0.106 ID) - (2.69 mm)							
4 Solid	G9	2.5	0.0984	#10 Solid	1A	0.102	2.6
6 Solid	H5	3.1	0.122	#8 Solid	1D	0.128	3.25
5.5 Concentric	B5	3.0	0.118	#10 Concentric	1B	0.116	2.95
w/B1331K sleeve (0.140 ID) - (3.56 mm)							
8.0 Concentric	E0	3.6	0.142	#8 Concentric	1E	0.146	3.7
10 Solid	-	3.8	0.150	#6 Solid	1G	0.162	4.1
10 Concentric	W2	4.2	0.162	#7 Concentric	7L	0.164	4.2
14 Concentric	B0	4.8	0.189	#6 Concentric	1H	0.184	4.7
w/B1331H sleeve (0.106 ID) - (5.38 mm)							
16 Solid	-	4.5	0.177	#4 Solid	1K	0.204	5.2
16 Concentric	W3	5.2	0.204	#5 Concentric	3Y	0.205	5.2
22 Concentric	A8	6.0	0.236	#4 Concentric	1L	0.232	5.9
25 Solid	W5	5.6	0.220	#3 Solid	1P	0.229	5.8
25 Concentric	Y1	6.4	0.260	#3 Concentric	1Q	0.260	6.6
25 Ropelay	X1	-	-	-	-	-	-
30 Concentric	A6	6.9	0.276	#2 Concentric	1V	0.292	7.4
35 Solid	W7	6.7	0.264	#2 Solid	1T	0.258	6.6
35 Concentric	Y2	7.7	0.305	#2 Concentric	1V	0.292	7.4
35 Ropelay	X2	-	-	-	-	-	-
38 Concentric	D5	7.8	0.315	#2 Concentric	1V	0.292	7.4
40 Concentric	E5	8.4	0.331	#1 Concentric	1Y	0.332	8.4
50 Solid	W6	8.0	0.315	1/0 Solid	2B	0.325	8.3
50 Concentric	Y3	9.0	0.354	1/0 Concentric	2C	0.373	9.5
50 Ropelay	X3	-	-	-	-	-	-
55 Concentric	G5	9.6	0.378	1/0 Concentric	2C	0.373	9.5
60 Concentric	L9	10.0	0.394	2/0 Concentric	2G	0.419	10.6
70 Solid	W8	10.0	0.394	3/0 Solid	2K	0.410	10.4
70 Concentric	Y4	10.9	0.430	2/0 Concentric	2G	0.419	10.6
70 Ropelay	-	-	-	-	-	-	-
80 Concentric	R4	11.5	0.453	3/0 Concentric	2L	0.470	12.0
95 Concentric	Y5	12.6	0.505	4/0 Concentric	2Q	0.528	13.4
95 Ropelay	X5	-	-	-	-	-	-
100 Concentric	X4	13.0	0.512	4/0 Concentric	2Q	0.528	13.4
120 Concentric	Y6	14.2	0.567	250MCM	2V	0.575	14.6
120 Ropelay	X6	-	-	-	-	-	-
125 Concentric	R6	14.5	0.571	250MCM	2V	0.575	14.6
150 Concentric	Y7	16.1	0.634	300MCM	3A	0.630	16.0
150 Ropelay	X7	-	-	-	-	-	-
160 Concentric	V7	-	-	-	-	-	-
185 Concentric	Y8	17.7	0.700	350MCM	3D	0.681	17.3
185 Ropelay	X8	-	-	-	-	-	-
200 Concentric	D7	18.2	0.717	400MCM	3H	0.728	18.5
240 Concentric	Y9	20.3	0.801	500MCM	3Q	0.813	20.7
240 Ropelay	X9	-	-	-	-	-	-
250 Concentric	V9	20.7	0.815	500MCM	3Q	0.813	20.7
300 Concentric	Y0	22.5	0.891	600MCM	3X	0.893	22.7
300 Ropelay	X0	-	-	-	-	-	-
315 Concentric	V0	-	-	-	-	-	-
325 Concentric	S4	23.4	0.922	700MCM	4G	0.964	24.5
400 Concentric	V1	26.2	1.03	800MCM	4Q	1.031	26.2
400 Ropelay	V6	-	-	-	-	-	-
500 Concentric	P9	28.8	1.13	1000MCM	4Y	1.152	29.3
500 Ropelay	W4	-	-	-	-	-	-
600 Concentric	R9	31.9	1.26	1200MCM	5G	1.263	32.1
625 Concentric	W9	32.8	1.29	1250MCM	5J	1.289	32.7
625 Ropelay	W0	-	-	-	-	-	-
725 Concentric	R0	35.2	1.39	1400MCM	5Q	1.364	34.6
800 Concentric	X8	36.8	1.45	1600MCM	5X	1.459	37.1
800 Ropelay	V2	-	-	-	-	-	-
850 Concentric	Q1	37.6	1.48	1700MCM	7G	1.506	38.2
1000 Concentric	V3	41.6	1.64	2000MCM	7G	1.632	41.5
1000 Ropelay	V4	-	-	-	-	-	-

F.1 - Metric Cable Sizes and Code, in Square Millimeters (MM2), abbrev. (QMM)

Cadweld - Technical Advantages

THE CADWELD WELD

- Has a current-carrying capacity equal to that of the conductor
- Creates a permanent bond that withstands repeated fault currents and will not loosen, deteriorate or increase in resistance
- Consistently performs the best in independent IEEE® 837 tests
- Is easy to check visibly for quality

RELIABILITY

As the molecular bond eliminates the concept of surface contact, an electrolyte cannot penetrate between the conductors and cause oxidation and deterioration in the course of time.

CORROSIVE ENVIRONMENTS

This reliability is of particular interest for humid or chemical environments or for bonds directly buried in the ground.

ABILITY TO WITHSTAND HIGH CURRENT

The melting temperature of Cadweld connection is higher than the melting temperature of copper (1082°C). For this reason, in the event of abnormal heating due to a high fault current, the conductor is destroyed before the connection.

CONDUCTIVITY

The Cadweld connections form a solid bond around the conductors assuring continuity. The cross sectional area of the weld has greater current carrying capacity than the conductors.

PERFORMANCE

Standard Cadweld welds have a cross section greater than that of the conductors to be joined, which compensates for the difference in resistivity between the conductor and the welding material.

Consequently, under fault conditions the weld will always remain cooler than the conductor.

If special applications do not allow for the required increase in cross section to be employed, the use of the formula:

$$R = \frac{\rho \times l}{S} \text{ and } V = R \times I$$

will make it possible to define precisely the resistance of the Cadweld weld.

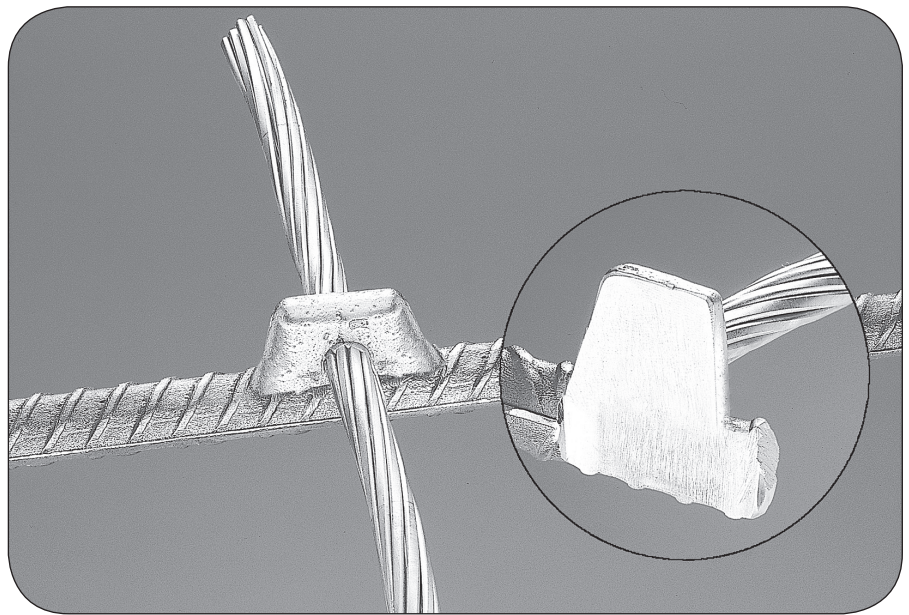

CORROSION TEST

This accelerated ageing test, carried out in a saline environment at a controlled temperature, demonstrates that Cadweld welds retain all their electrical properties during the period of the test whereas the resistance of mechanical connections increase with time and this alters their conductive properties.

Cadweld's exceptional performance is due to its reliability resulting from the molecular bond.

Comparison between Cadweld Bonded Connection and Mechanical Connection Cadweld Weld (Metal A) (Metal B).

The Cadweld bonded connection provides permanent conductivity over the whole of the section due to molecular bonding between the metal surfaces.

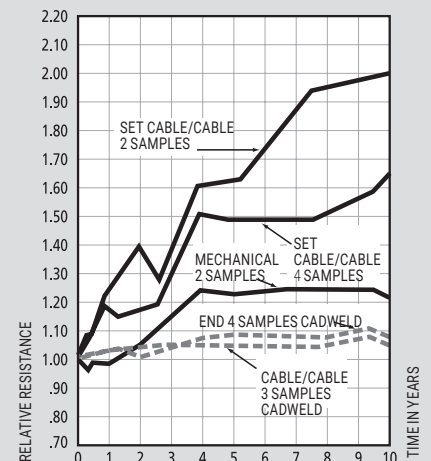

Comparison between Cadweld Bonded Connection and Mechanical Connection

CADWELD WELD

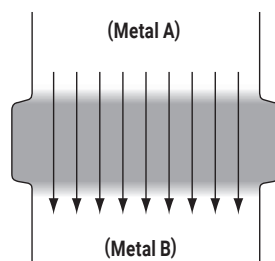

The Cadweld bonded connection provides conductivity over the whole of the section due to molecular bonding between the metal surfaces.

MECHANICAL CRIMPED CONNECTION

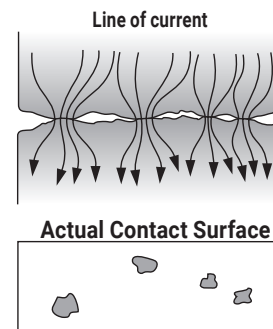

The mechanical connection presents a significant difference between the apparent contact surface and the actual surface.

Cadweld - Technical Advantages

GROUNDING SYSTEM – CONDUCTORS AND CONNECTORS

The grounding conductor size is based on the maximum magnitude and duration of available fault current, and on the type of connections being used in the grounding system.

IEEE® Std. 80-1986, Guide for Safety in Substation Grounding, uses a fusing formula as the basis for selecting minimum conductor size to avoid fusing (melting) under fault conditions.

This formula can be simplified to the following:

$$A = K \cdot I \sqrt{S}$$

- Where: **A** = Conductor size in mm²
K = Constant from the following table
I = RMS fault current in amperes
S = Fault time in seconds

Based on the standard ambient temperature of 40° C.

MAX TEMP	CONSTANT K FOR ABOVE FORMULA		
	COPPER (Soft Drawn)	COPPERWELD (Dead Soft Annealed) 40%	COPPERWELD (Dead Soft Annealed) 30%
1083° C	3.55	5.30	6.10
450° C	4.65	6.96	8.04
350° C	5.12	7.67	8.85
250° C	5.90	8.85	10.22

The temperatures listed above for each material are specified in IEEE Std. 80-1986 to be used for different types of connecting means;

- Pressure type connectors 250° to 350° C*
- Brazed connections 450° C
- Exothermic welded connections 1083° C

*Except those that have been tested to and passed the requirements of IEEE Std. 837-1989.

RELATIVE SIZES

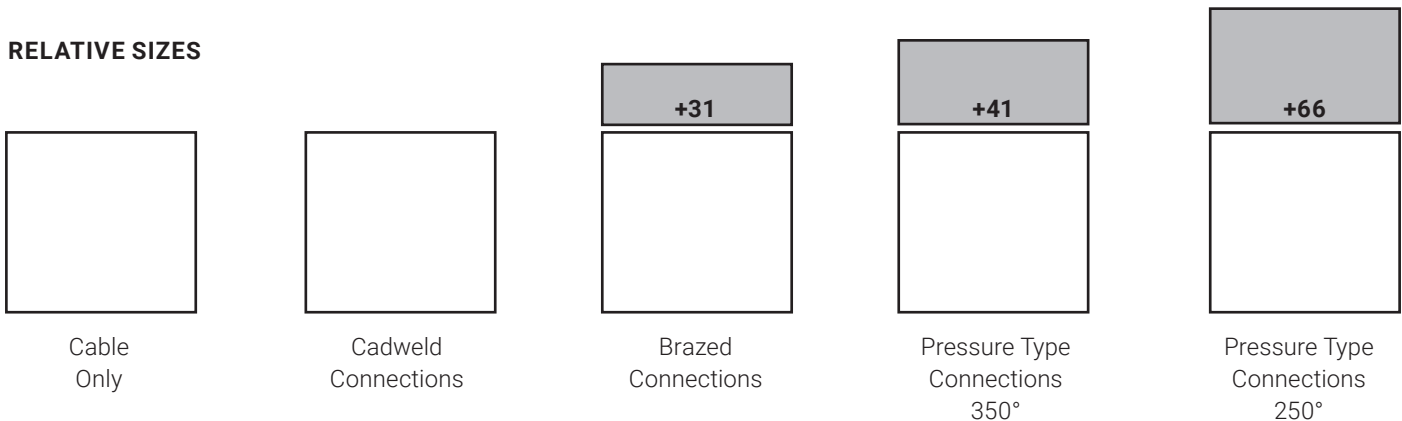

EXAMPLE – 25,000 Ampere, 2 second fault:

CONNECTION TYPE	CONDUCTOR SIZE
Cadweld Electrical	126 mm ² - use 150 mm ²
Brazed	164 mm ² - use 185 mm ²
Pressure Type (at 350° C)	181 mm ² - use 185 mm ²
Pressure Type (at 250° C)	209 mm ² - use 240 mm ²

Technical Information

CADWELD THE MOLECULAR BOND

CADWELD EXOTHERMIC CONNECTION

A WELDING PROCESS THAT ELIMINATES THE CONNECTION BY FORMING A MOLECULAR BOND.

Connections are the weak point of all electrical circuits and especially earthing circuits subjected to aging and corrosion. The capacity of an earthing circuit to protect the safety of personnel depends on the quality of the connections made.

BS 6651 (1992) STATES :

“Any joint other than welded represents a discontinuity in the current conducting system and is susceptible to variation and failure.”

CADWELD – THE MOLECULAR BOND

The Cadweld process provides a way to produce copper/copper, copper/galvanized or plain steel, copper/copper clad steel, copper/bronze/brass/stainless steel, steel/steel, molecular bonds with no external energy or heat source.

The principle consists of bringing together a welding materials and ignition agent in a suitable graphite mould.

The reduction of copper oxide by aluminium produces molten copper and aluminium oxide slag at extremely high temperatures.

The shape of the mould, its dimensions, and the size of the welding material, are all dependent on the items to be welded.

INSTALLATION IS EASY!

4 SIMPLE STEPS FOR PERMANENTLY WELDED ELECTRICAL CONNECTIONS

The Cadweld Plus Control Unit initiates the reaction of the metal crucible. The standard unit includes a 1.8 meter (6-foot) high temperature control unit lead. The lead attaches to the ignition strip using a custom made, purpose-designed termination clip.

After the termination clip is installed on the ignition strip, the installer pushes and holds the ignition button to start a charging and discharging sequence. Within a few seconds the control unit sends a predetermined voltage to the ignition strip and the reaction is initiated.

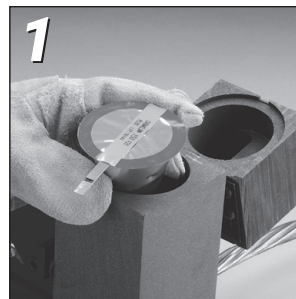
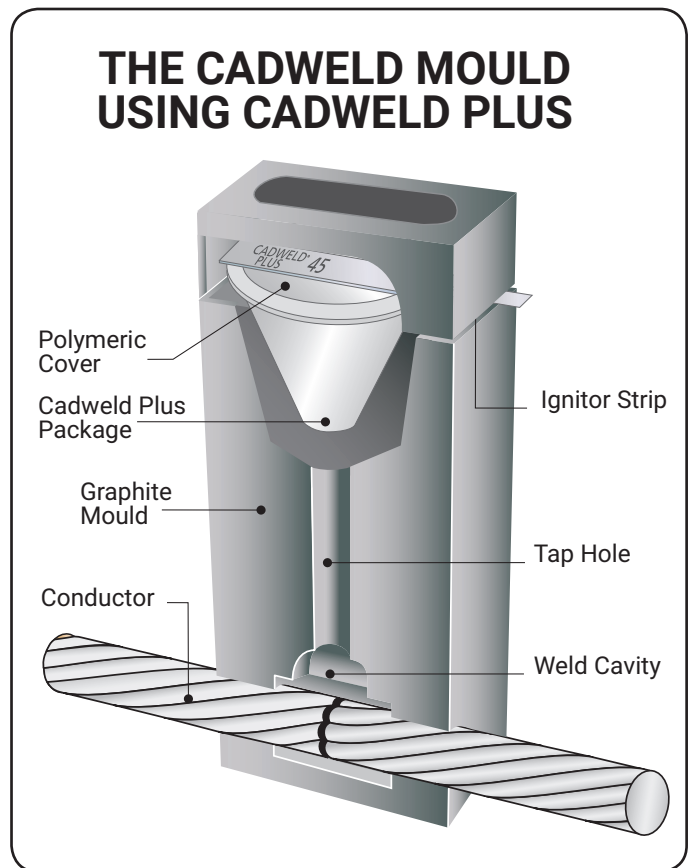

1 Insert Cadweld Plus package into mould

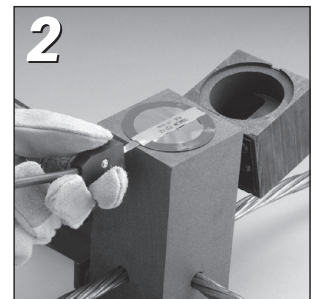

2 Attach control unit termination clip to ignition strip



3 Press and hold operating switch and wait for the ignition



4 Open the mould and remove the expended steel cup – no special disposal required

Cadweld Plus

CADWELD PLUS FOR GROUNDING APPLICATIONS

Article Number	Article Number	Size Identification Ring Color	Traditional Welding Material Part Number (Clear Cap)	Box Qty.
165700	165700	Black	15	20
165701	165701	Red	25	20
165702	165702	White	32	20
165703	165703	Light Blue	45	20
165704	165704	Dark Green	65	20
165705	165705	Gray	90	10
165706	165706	Orange	115	10
165707	165707	Dark Blue	150	10
165708	165708	Yellow	200	10
165709	165709	Purple	250	10
165710	165710	Light Green	use 2 x 150	10
165711	165711	Brown	use 2 x 200	10
165712	165712	Light Brown	500	10

CADWELD PLUS FOR GROUNDING APPLICATIONS

Cadweld Plus Part Number	Article Number	Size Identification Ring Color	Traditional Welding Material Part Number (Orange Cap)	Box Qty.
25PLUSXF19	165718	Red	25XF19	20
32PLUSXF19	165719	White	32XF19	20
45PLUSXF19	165720	Light Blue	45XF19	20
65PLUSXF19	165721	Dark Green	65XF19	20

Gram weight PLUS welding material type **i.e. 45PLUSF20**



PLUSCU

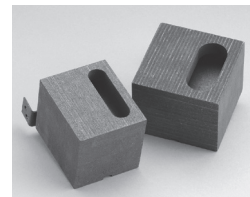

Baffle Cover Kit



PLUSCULD

Cadweld Plus Patent Numbers 6,553,911 6,835,910 6,703,578

ACCESSORIES

Part Number	Article Number	Description
PLUSCU	165738	Cadweld Plus Control Unit
PLUSCU15L	165745	Cadweld Plus Control Unit with 4.6 meters (15 ft.) Lead
PLUSCULD	165739	Control Unit Replacement Lead 1.8 meters (6 ft.)
PLUSCULD15	165746	Control Unit Replacement Lead 4.6 meters (15 ft.)
MC2X2KIT	165740	Kit, Baffle Cover, Graphite - 51 mm X 51 mm (2" X 2") Mould
MC25X3KIT	165744	Kit, Baffle Cover, Graphite - 64 mm X 76 mm (2 1/2" X 3") Mould
MC3X3KIT	165741	Kit, Baffle Cover, Graphite - 76 mm X 76 mm (3" X 3") Mould
MC4X4KIT	165742	Kit, Baffle Cover, Graphite - 102 mm X 102 mm (4" X 4") Mould

Cadweld Multi

4 Easy steps for multiple, permanently welded, electrical connections



Step 1 Layer batting and variable conductor sizes to be welded into dry mould



Step 2 Close mould and drop metal disk in place



Step 3 Dump welding material and tap bottom of container to release starting material



Step 4 Close the cover and ignite with flint ignitor. Open the mould after 10 seconds



The Cadweld Multi combines a versatile mould block and a range of gaskets (batting) to allow numerous different welded connections to be produced without the need to change the mould for each connection type.

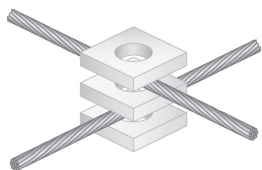

The process is similar to the traditional Cadweld with one distinct difference... there is no need to change the mould for different connection types.

The whole process is complete in about one minute. The connection table details the gasket quantities required for each weld.

CADWELD MULTI AVAILABLE ITEMS

Description	Part No.	Article No.	Box Qty.	Unit Weight (kg)	
Kit for 20 welds, in metallic box 14" x 13" x 6" (360 x 330 x 160 mm)	KITCDM01	167780	1	10.00	
Kit for 20 welds using Cadweld Plus, in metallic box (Control Unit sold separately) 14" x 13" x 11" (360 x 330 x 280 mm)	KITCDM01 PLUS	167781	1	11.50	
Made from the following items which can be ordered separately:			Qty. in Kit		
Mould	CDM01	234720	1	1.000	
Handle Clamp	FMCDM01	120882	1	1.100	
Set of 33 battings/gaskets	SCDM01	120886	2	1	0.200
Welding material 90*	90	163040	2 boxes of 10	10	0.090
Cadweld Plus Welding Material**	90PLUSF20	165705	2 boxes of 10	10	0.158
Toolset TS-6A, including:	TS6A	169930	1	1	0.490
• gloves	• cardcloth brush				
• soft brush	• flint ignitor				

* in KITCDM01 = Traditional Cadweld Multi Kit

** in KITCDM01PLUS = Cadweld Plus Multi Kit

Cadweld Multi

CADWELD MULTI CONNECTION CAPABILITIES

Copper Cable/Solid to Copper Cable/Solid

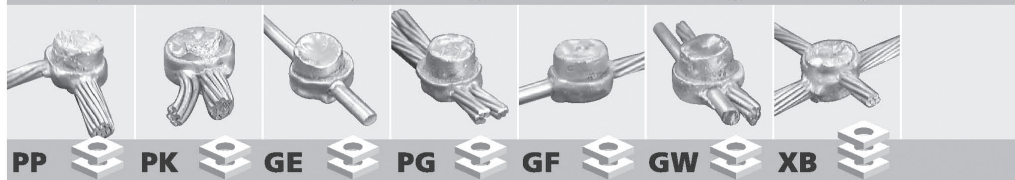
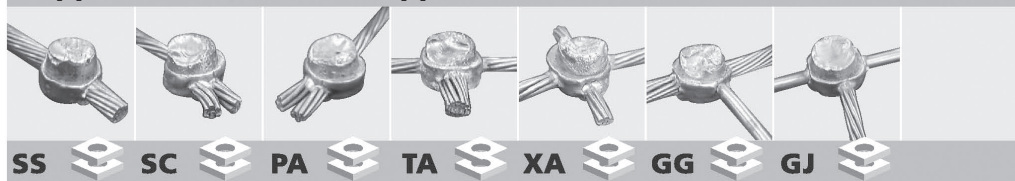

• Copper cable/solid sizes up to 1/0 (50 mm²) stranded or .40" (10 mm) diameter

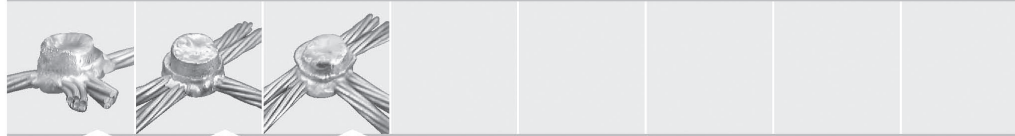

• Copper cable/solid sizes up to #3 (25 mm²) stranded or .26" (6,5 mm) diameter

Copper Cable/Solid/Strip to Rebar

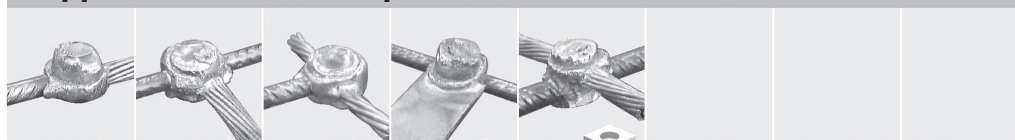

• Copper conductor sizes up to 1/0 (50 mm²) stranded or .40" (10 mm) diameter
 • Copper or steel strip/lug sizes up to 1" x .138" (30 x 3,5 mm)
 • Rebar sizes up to #3 (10 mm)

Copper Cable/Solid to Copper or Steel Strip/Lug

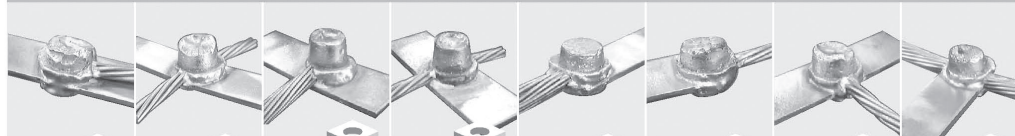

• Copper conductor sizes up to 1/0 (50 mm²) stranded or .40" (10 mm) diameter
 • Copper or steel strip/lug sizes up to 1" x .138" (30 x 3,5 mm)

Copper Strip to Copper Strip

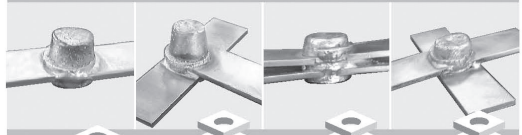

• BB and CG 1" x (.020" - .118"), (30 x 3,5 mm)
 • BG and EB 1" x (.020" - .079"), (30 x 3 mm)

Galvanized Steel Strip to Galvanized Steel Strip



• Galvanized steel strip sizes up to 1" x .138" (30 x 3,5 mm)

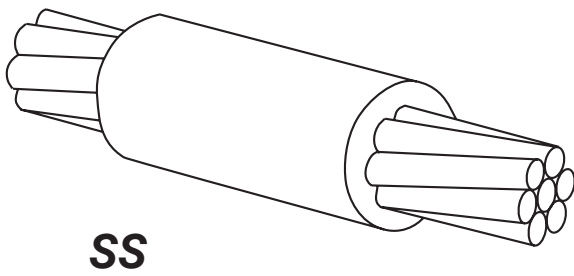

HORIZONTAL SPLICE

Splice of horizontal cables.

- Concentric stranded copper cable unless otherwise noted.
- Solid conductor may be copper or Copperweld.
- Also available are splices of different and mixed cable sizes. For Copperweld DSA cables, contact nVent.
- **Bold letter** in mould part number is the price key.

REQUIRED TOOLS

	Article No.	Part No.
Handle Clamps		
for C Price Key Moulds	161000	L160
for D Price Key Moulds	161020	L159
Cadweld Plus Control Unit or	165738	PLUSCU
Flint Ignitor	165000	T320

SUGGESTED TOOLS

Conductor Cleaning Brush	165130	T313
Slag Removal Spade		
#65 w/m & smaller	182125	B136A
#90 w/m & larger	182130	B136B
Mould Cleaning Brush	165260	T394
Cable Clamp	165020	B265
Torch Head	140160	T111

SS

CABLE SIZE (sq mm)	MOULD PART NO.	WELDING MATERIAL ¹
16*	SSCW3*	25
25	SSCY1	32
35	SSCY2	32
50	SSCY3	45
70	SSCY4	65
95	SSCY5	90
120	SSCY6	115
150	SSCY7	115
185	SSCY8	150
240	SSCY9	200
300	SSCY0	2 x 150**
8 mm Ø	SSCW6	45
10 mm Ø	SSCW8	65

*Packing: B112, sleeve

¹ For Cadweld Plus add suffix "PLUSF20" (refer page 8)

**For Cadweld Plus use 300PLUSF20

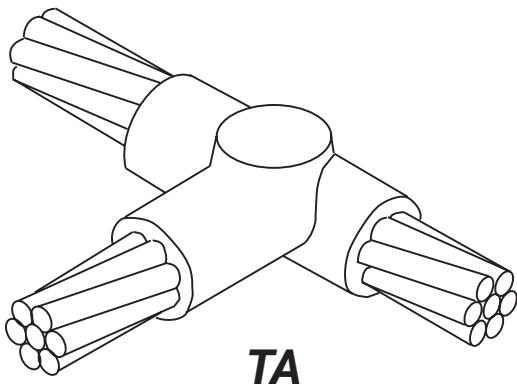

HORIZONTAL TEE CONNECTIONS

Tee of horizontal run and tap cables.

- Concentric stranded copper cable unless otherwise noted.
- Solid conductor can be copper or Copperweld.
- **Bold letter** in mould part number is the price key.

REQUIRED TOOLS

	Article No.	Part No.
Handle Clamps		
for C Price Key Moulds	161000	L160
for D Price Key Moulds	161020	L159
Cadweld Plus Control Unit or	165738	PLUSCU
Flint Ignitor	165000	T320

SUGGESTED TOOLS

Conductor Cleaning Brush	165130	T313
Slag Removal Spade		
#65 w/m & smaller	181225	B136A
#90 w/m & larger	181230	B136B
Mould Cleaning Brush	165260	T394
Cable Clamp	165020	B265
Torch Head	140160	T111

TA

CABLE SIZE (sq mm) run		MOULD PART NO. tap	WELDING MATERIAL ¹
16*	16*	TACW3W3	32
25	25	TACY1Y1	32
25	16*	TACY1W3	45
35	35	TACY2Y2	45
35	25	TACY2Y1	45
35	16*	TACY2W3	45
50	50	TACY3Y3	90
50	35	TACY3Y2	45
50	25	TACY3Y1	45
50	16*	TACY3W3	45
70	70	TACY4Y4	90
70	50	TACY4Y3	90
70	35	TACY4Y2	45
70	25	TACY4Y1	45
70	16*	TACY4W3	45
95	95	TACY5Y5	115
95	70	TACY5Y4	90
95	50	TACY5Y3	90
95	35	TACY5Y2	90
95	25	TACY5Y1	90
95	16*	TACY5W3	90

CABLE SIZE (sq mm) run		MOULD PART NO. tap	WELDING MATERIAL ¹
95	16*	TACY5W3	90
120	120	TACY6Y6	150
120	95	TACY6Y5	150
120	70	TACY6Y4	90
120	50	TACY6Y3	90
120	35	TACY6Y2	90
150	150	TACY7Y7	200
150	120	TACY7Y6	150
150	95	TACY7Y5	150
150	70	TACY7Y4	90
185	185	TACY8Y8	200
185	150	TACY8Y7	200
185	120	TACY8Y6	200
240	240	TACY9Y9	2 x 150**
240	185	TACY9Y8	200
240	150	TACY9Y7	200
240	120	TACY9Y6	200
8 mm Ø	8 mm Ø	TACW6W6	90
10 mm Ø	8 mm Ø	TACW8W6	90
10 mm Ø	10 mm Ø	TACW8W8	90

*Packing: B112, sleeve

¹For Cadweld Plus add suffix "PLUSF20" (refer page 8)

¹For Cadweld Plus add suffix "PLUSF20" (refer page 8)

**For Cadweld Plus use 300PLUSF20

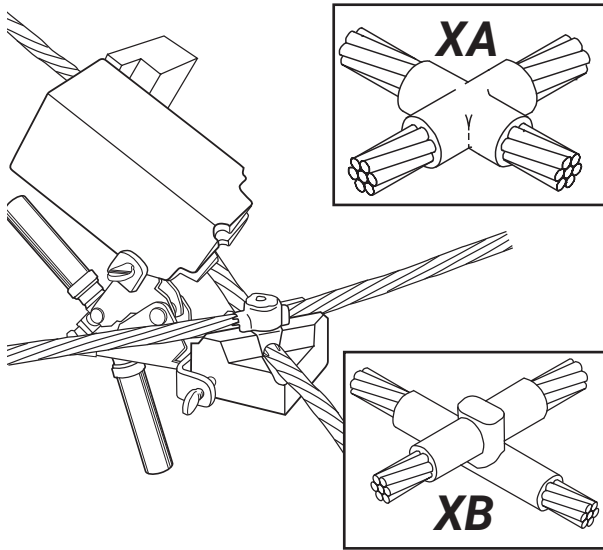

XA

CABLE SIZE (sq mm)		MOULD PART NO.	WELDING MATERIAL ¹
run	tap		
25	25	XACY1Y1	45
35	35	XACY2Y2	65
35	25	XACY2Y1	65
50	50	XACY3Y3	90
50	35	XACY3Y2	90
70	70	XACY4Y4	115
70	50	XACY4Y3	115
95	95	XACY5Y5	200
95	70	XACY5Y4	150
95	50	XACY5Y3	150
120	120	XACY6Y6	200
120	95	XACY6Y5	200
120	70	XACY6Y4	200
150	150	XACY7Y7	250
150	120	XACY7Y6	250
150	95	XACY7Y5	200
150	70	XACY7Y4	200
185	185	XACY8Y8	250
185	150	XACY8Y7	250
185	120	XACY8Y6	250
240	240	XADY9Y9	500
240	185	XADY9Y8	2 x 200*
240	150	XADY9Y7	2 x 200*
240	120	XADY9Y6	2 x 150**

¹For Cadweld Plus add suffix "PLUSF20" (refer page 8)

*For Cadweld Plus use 400PLUSF20

**For Cadweld Plus use 300PLUSF20

HORIZONTAL X CONNECTIONS

XA – Cross of horizontal cables, tap cable cut – cables in same plane.

XB – Cross of horizontal cables, lapped and not cut.

- Concentric stranded copper cable unless otherwise noted
- Solid conductor may be copper or Copperweld.
- **Bold letter** in mould part number is the price key.

REQUIRED TOOLS

	Article No.	Part No.
Handle Clamps		
for C Price Key Moulds	161000	L160
for D Price Key Moulds	161020	L159
Cadweld Plus Control Unit or	165738	PLUSCU
Flint Ignitor	165000	T320

SUGGESTED TOOLS

	Article No.	Part No.
Conductor Cleaning Brush	165130	T313
Slag Removal Spade		
#65 w/m & smaller	182125	B136A
#90 w/m & larger	182130	B136B
Mould Cleaning Brush	165260	T394
Cable Clamp	165020	B265
Torch Head	140160	T111

ADDITIONAL NOTES

- B136C cleaning tool supplied with each XB mould.
- All Q price moulds require L160 handle clamp.
- All Z price moulds require L159 handle clamp.

XB

CABLE SIZE (sq mm)		MOULD PART NO.	WELDING MATERIAL ¹
run	tap		
25	25	XBCY1Y1	65
35	35	XBCY2Y2	90
50	50	XBQY3Y3	150
70	70	XBQY4Y4	200
95	95	XBQY5Y5	250
120	120	XBQY6Y6	2 x 150**
150	150	XBZY7Y7	2 x 200*
185	185	XBZY8Y8	500
240	240	XBZY9Y9	3 x 250***

¹For Cadweld Plus add suffix "PLUSF20" (refer page 8)

*For Cadweld Plus use 400PLUSF20

**For Cadweld Plus use 300PLUSF20

***For Cadweld Plus use 750PLUSF20

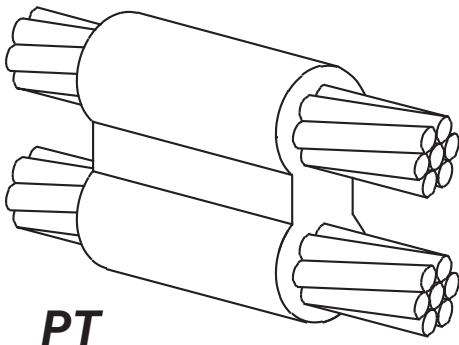

PT

CABLE SIZE (sq mm) run		MOULD PART NO. tap	WELDING MATERIAL ¹
25	25	PT C Y1Y1	45
35	35	PT C Y2Y2	65
35	25	PT C Y2Y1	65
50	50	PT C Y3Y3	90
50	35	PT C Y3Y2	65
70	70	PT C Y4Y4	115
70	50	PT C Y4Y3	115
95	95	PT C Y5Y5	200
95	70	PT C Y5Y4	150
95	50	PT C Y5Y3	150
120	120	PT C Y6Y6	250
120	95	PT C Y6Y5	200
120	70	PT C Y6Y4	150
150	150	PT D Y7Y7	2 x 150*
150	120	PT C Y7Y6	250
150	95	PT C Y7Y5	200
150	70	PT C Y7Y4	150
185	185	PT D Y8Y8	2 x 150*
185	150	PT D Y8Y7	2 x 150*
185	120	PT C Y8Y6	250
240	240	PT D Y9Y9	2 x 200**
240	185	PT D Y9Y8	2 x 150*
240	150	PT D Y9Y7	2 x 150*
240	120	PT C Y9Y6	250

¹For Cadweld Plus add suffix "PLUSF20" (refer page 8)

*For Cadweld Plus use 300PLUSF20

**For Cadweld Plus use 400PLUSF20

PARALLEL HORIZONTAL CONDUCTORS

Parallel through connection of horizontal cables.

- Run conductor is on the bottom of type PT moulds.
- Concentric strand copper cable unless otherwise noted.
- Solid conductor may be copper or Copperweld®.
- **Bold letter** in mould part number is the price key.

REQUIRED TOOLS

	Article No.	Part No.
Handle Clamps		
for C Price Key Moulds	161000	L160
for D Price Key Moulds	161020	L159
Cadweld Plus Control Unit or	165738	PLUSCU
Flint Ignitor	165000	T320

SUGGESTED TOOLS

Conductor Cleaning Brush	165130	T313
Slag Removal Spade		
#65 w/m & smaller	182125	B136A
#90 w/m & larger	182130	B136B
Mould Cleaning Brush	165260	T394
Cable Clamp	165020	B265
Torch Head	140160	T111

Horizontal Steel Surface

HA/HS

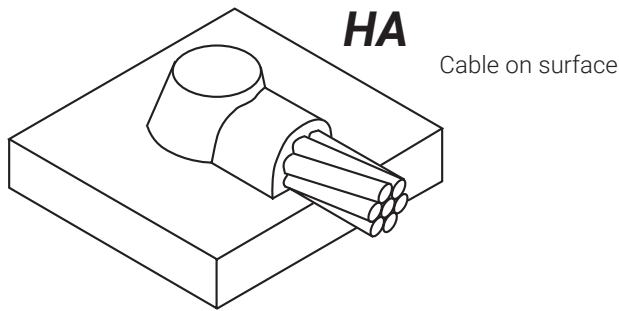

HA

Cable on surface

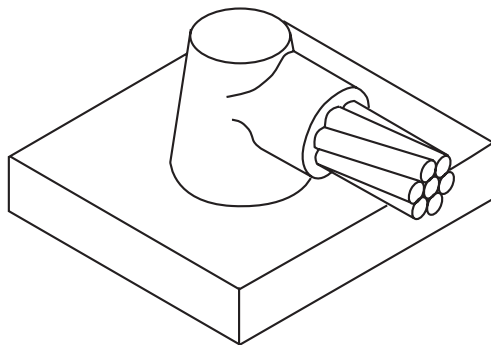

HS

Cable off surface

HA

CABLE SIZE (sq mm)	MOULD PART NO.	WELDING MATERIAL ¹
25	HAA \mathbf{Y} 1	45
35	HAA \mathbf{Y} 2	45
50	HAA \mathbf{Y} 3	45
70	HAA \mathbf{Y} 4	65

¹For Cadweld Plus add suffix "PLUSF20" (refer page 8)

HS

CABLE SIZE (sq mm)	MOULD PART NO.	WELDING MATERIAL ¹
95	HSC \mathbf{Y} 5	115
120	HSC \mathbf{Y} 6	115
150	HSC \mathbf{Y} 7	150
185	HSC \mathbf{Y} 8	200
240	HSC \mathbf{Y} 9	200

¹For Cadweld Plus add suffix "PLUSF20" (refer page 8)

HORIZONTAL STEEL SURFACE

Horizontal concentric copper conductor to flat steel surface or top of horizontal pipe

- Cadweld also has a complete product line for cathodic protection connections. See catalogue CA1A.
- A test weld should be made to check the possibility of burn-through on thin sections or thin wall pipe.
- Concentric stranded copper cable listed.
- **Bold letter** in mould part number is the price key.

REQUIRED TOOLS

	Article No.	Part No.
Handle Clamps*		
Flat Surface for C Price Key Moulds	161000	L160
Flat Surface for D Price Key Moulds	161020	L159
Pipe (curved surface) for C Price Key Moulds		B160V
Pipe (curved surface) for D Price Key Moulds		B159V
Cadweld Plus Control Unit or	165738	PLUSCU
Flint Ignitor	165000	T320

SUGGESTED TOOLS

Conductor Cleaning Brush	165030	T313
Slag Removal Spade		
#65 w/m & smaller	182125	B136A
#90 w/m & larger	182130	B136B
Mould Cleaning Brush	165260	T394
Cable Clamp	165020	B265
Torch Head	140160	T111
Rasp	162420	T321

*Handles are included with A Price Key Moulds.

CABLE TO STEEL PIPE (TYPES HA AND HS) –
USE FLAT SURFACE MOULD PART NUMBER WITH SUFFIX.

Cable	Nominal Pipe Diameter	Suffix
35 mm ² and Smaller	Less than 350 mm Greater than 350 mm	Nominal Diameter (mm) None
50 mm ² thru 120 mm ²	Less than 760 mm Greater than 762 mm	Nominal Diameter (mm) None

Example: 35 mm² cable, on 100 mm diameter pipe HAA-Y2-100
95 mm² cable on 250 mm diameter pipe HSC-Y5-250

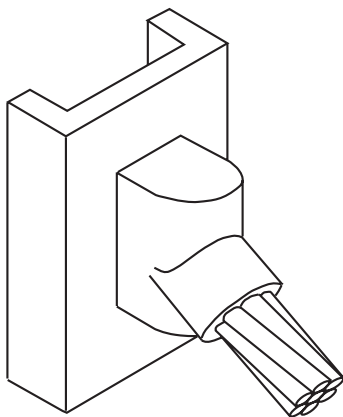

VS

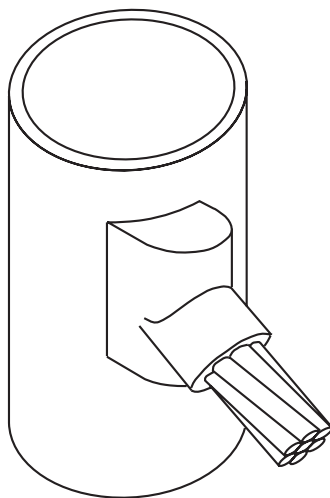

VS

CABLE SIZE sq mm	MOULD PART NO.	WELDING MATERIAL ¹
25	VSCY1	45
35	VSCY2	45
50	VSCY3	90
70	VSCY4	90
95	VSCY5	115
120	VSCY6	115
150	VSCY7	150
185	VSCY8	200
240	VSCY9	200

¹For Cadweld Plus add suffix "PLUSF20" (refer page 8)

VERTICAL STEEL SURFACE

Cable down at 45° to vertical steel surface including pipe.
Cable to vertical flat steel surface; cable to side of vertical or horizontal steel pipe.

- Cadweld also has a complete product line for cathodic protection connections.
- Concentric stranded copper cable listed.
- A test weld should be made to check the possibility of burn through on thin sections or thin wall pipe.
- **Bold letter** in mould part number is the price key.

REQUIRED TOOLS

	Article No.	Part No.
Handle Clamps		
Flat Surface for C Price Key Moulds	161000	L160
for D Price Key Moulds	161020	L159
Pipe for C Price Key Moulds		B160V
(to 100 mm dia.) for D Price Key Moulds		B159V
(Pipes 10ø-250 mm dia. add B158)		
Cadweld Plus Control Unit or	165738	PLUSCU
Flint Ignitor	165000	T320

SUGGESTED TOOLS

Conductor Cleaning Brush	165030	T313
Slag Removal Spade	See Cadweld Table	
Mould Cleaning Brush	165260	T394
Cable Clamp	165020	B265
Torch Head	140160	T111
Rasp	162420	T321

ADDITIONAL NOTES

For flat vertical surfaces, on an H column or angle, the following attachment can be used to secure the mould.

for use with L160	B134
for use with L159	B135

CABLE TO VERTICAL STEEL PIPE –

Use flat surface mould part number; add **V** and suffix.

Cable	Nominal Pipe Diameter	Suffix
25 mm ² thru	Less than 80 mm	Nominal Pipe Diameter
120 mm ²	812.8 mm and larger	None

Example: 70 mm² to 102 mm pipe, VSC-Y4-102V

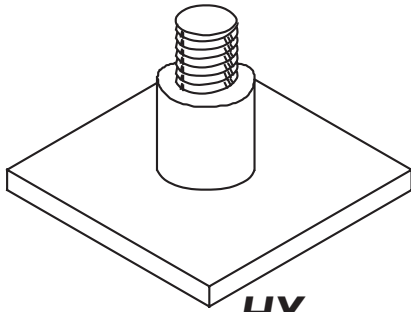

HX

Vertical stud to horizontal steel surface

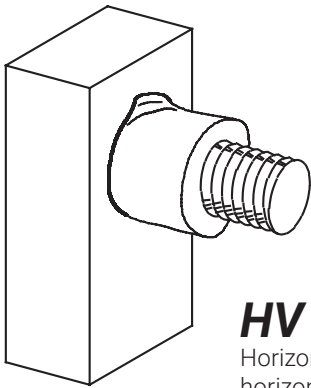

HV

Horizontal stud to horizontal steel surface

HX

THREAD DESCRIPTION	MOULD PART NO.	WELDING MATERIAL ¹
M6	HXC-6	25
M8	HXC-8	32
M10	HXC-10	45
M12	HXC-12	45
M16	HXC-16	90

¹For Cadweld Plus add suffix "PLUSF20" (refer page 8)

STEEL STUDS
 Connections of steel studs to steel surfaces.
 Studs on grounded structures provide a convenient point of attachment of temporary protective ground clamps.
 • **Bold letter** in mould part number is the price key.

REQUIRED TOOLS

	Article No.	Part No.
Handle Clamps		
for C Price Key Moulds	161000	L160
for D Price Key Moulds	161020	L159
Cadweld Plus Control Unit or	165738	PLUSCU
Flint Ignitor	165000	T320

SUGGESTED TOOLS

Mould Cleaning Brush	165260	T394
Rasp	162420	T321
Torch Head	140160	T111
Mould Scraper Tool		
#65 w/m & smaller		B136A
#90 w/m & larger		B136B

HV

THREAD DESCRIPTION	MOULD PART NO.	WELDING MATERIAL ¹
M6	HVC-6	25
M10	HVC-P100	45
M12	HVC-P120	65
M16	HVC-P160	115

¹For Cadweld Plus add suffix "PLUSF20" (refer page 8)

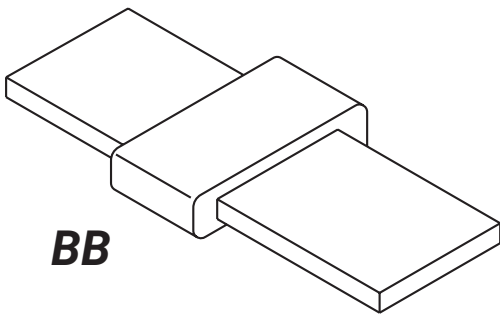
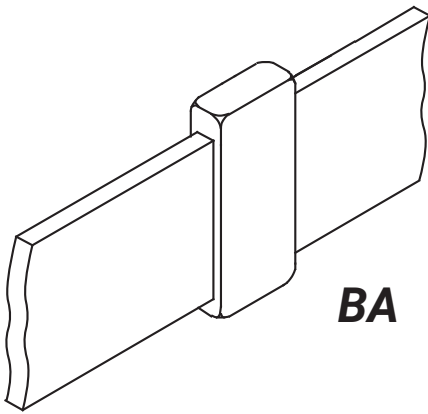

COPPER BUSBAR SPLICE

TYPE BA – Horizontal, on-edge, busbar.

TYPE BB – Horizontal busbars.

• **Bold letter** in mould part number is the price key.

REQUIRED TOOLS

	Article No.	Part No.
Handle Clamps		
for C Price Key Moulds	161000	L160
for D Price Key Moulds	161020	L159
Cadweld Plus Control Unit or	165738	PLUSCU
Flint Ignitor	165000	T320

SUGGESTED TOOLS

Conductor Cleaning Brush	165130	T313
Slag Removal Spade		
#65 w/m & smaller	182125	B136A
#90 w/m & larger	182130	B136B
Mould Cleaning Brush	165260	T394
Cable Clamp	165020	B265
Torch Head	140160	T111

BA

BUSBAR SIZE	MOULD PART NO.	WELDING MATERIAL ¹
3X25	BACCAJ	65
3X50	BACCAM	90
4X40	BACEAL	115
4X50	BACEAM	115
5X40	BACFAL	150
5X50	BACFAM	200
6X25	BACPAJ	115
6X50	BACPAM	150

¹For Cadweld Plus add suffix "PLUSF20" (refer page 8)

BB

BUSBAR SIZE	MOULD PART NO.	WELDING MATERIAL ¹
3X25	BB CA J	90
3X50	BB RC AM	150
4X40	BB CE AL	150
4X50	BB RE AM	150
5X40	BB CF AL	150
5X50	BB RF AM	200
6X25	BB CP AJ	115
6X50	BB RP AM	250

¹For Cadweld Plus add suffix "PLUSF20" (refer page 8)

Busbar Tape

BM/BQ

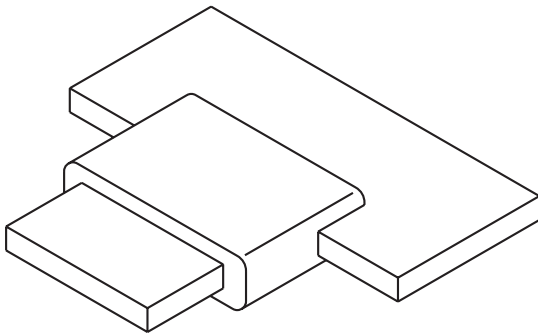

BM

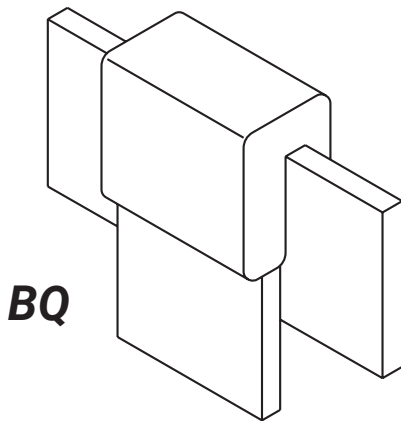

BQ

COPPER BUSBAR

TYPE BM – Tee tap – horizontal busbars.

TYPE BQ – Tee tap down – horizontal, on-edge, busbars.

• **Bold letter** in mould part number is the price key.

REQUIRED TOOLS

	Article No.	Part No.
Handle Clamps		
for C Price Key Moulds	161000	L160
for D Price Key Moulds	161020	L159
Cadweld Plus Control Unit or	165738	PLUSCU
Flint Ignitor	165000	T320

SUGGESTED TOOLS

Conductor Cleaning Brush	165130	T313
Slag Removal Spade		
#65 w/m & smaller	182125	B136A
#90 w/m & larger	182130	B136B
Mould Cleaning Brush	165260	T394
Cable Clamp	165020	B265
Torch Head	140160	T111

BM

BUSBAR SIZE	MOULD PART NO.	WELDING MATERIAL ¹
3X25	BM C CAJCAJ	90
3X50	BM D CAMCAM	250
4X40	BM C EALEAL	150
4X50	BM D EAMEAM	200
5X40	BM C FALFAL	150
5X50	BM D FAMFAM	200
6X25	BM C PAJPAJ	115
6X50	BM D PAMPAM	250

¹For Cadweld Plus add suffix "PLUSF20" (refer page 8)

BQ

BUSBAR SIZE	MOULD PART NO.	WELDING MATERIAL ¹
3X25	BQ C CAJCAJ	90
3X50	BQ D CAMCAM	200
4X40	BQ C EALEAL	150
4X50	BQ D EAMEAM	200
5X40	BQ C FALFAL	150
5X50	BQ D FAMFAM	200
6X25	BQ C PAJPAJ	150
6X50	BQ D PAMPAM	2 x 250*

¹For Cadweld Plus add suffix "PLUSF20" (refer page 8)

*For Cadweld Plus use 500PLUSF20

Cable to Busbar Tape

LE

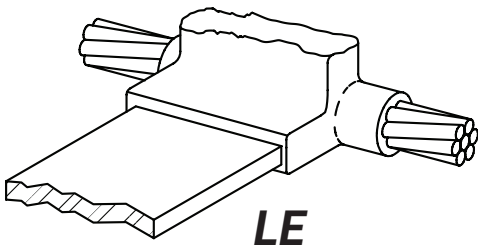

LE

CABLE SIZE (sq mm)	BUSBAR (mm)	MOULD PART NO.	WELDING MATERIAL ¹
16	2x20	LE CW 3BAH*	45
	2x25	LE CW 3BAJ*	65
	3x20	LE CW 3CAH*	65
	3x25	LE CW 3CAJ*	65
25	2x20	LE CY 1BAH	45
	2x25	LE CY 1BAJ	45
	3x20	LE CY 1CAH	45
	3x25	LE CY 1CAJ	45
	4x25	LE CY 1EAJ	65
35	2x25	LE CY 2BAJ	45
	3x20	LE CY 2CAH	45
	3x25	LE CY 2CAJ	45
	4x25	LE CY 2EAJ	65
50	2x25	LE CY 3BAJ	65
	3x20	LE CY 3CAH	65
	3x25	LE CY 3CAJ	65
	4x25	LE CY 3EAJ	90
70	3x25	LE CY 4CAJ	90
	3x30	LE CY 4CAK	90
	4x25	LE CY 4EAJ	115
	4x30	LE CY 4EAK	115
	5x30	LE CY 4FAK	115
95	3x25	LE CY 5CAJ	90
	3x30	LE CY 5CAK	90
	4x25	LE CY 5EAJ	150
	4x30	LE CY 5EAK	150
	5x30	LE CY 5FAK	150
	6x40	LE CY 5PAL	200
120	3x25	LE CY 6CAJ	115
	3x30	LE CY 6CAK	115
	4x25	LE CY 6EAJ	150
	4x30	LE CY 6EAK	150
	5x30	LE CY 6FAK	200
	6x40	LE CY 6PAL	200

¹ For Cadweld Plus add suffix "PLUSF20" (refer page 8)

* Requires B112 Sleeve

CABLE TO BUSBAR

Horizontal tee - tap of copper busbar to cable run

- Concentric stranded copper cable as listed
- **Bold letter** in mould part number is the price key.

REQUIRED TOOLS

	Article No.	Part No.
Handle Clamps		
for C Price Key Moulds	161000	L160
for D Price Key Moulds	161020	L159
Cadweld Plus Control Unit or	165738	PLUSCU
Flint Ignitor	165000	T320

SUGGESTED TOOLS

	Article No.	Part No.
Conductor Cleaning Brush	165130	T313
Slag Removal Spade		
#65 w/m & smaller	182125	B136A
#90 w/m & larger	182130	B136B
Mould Cleaning Brush	165260	T394
Cable Clamp	165020	B265
Torch Head	140160	T111

Busbar Tape

EB

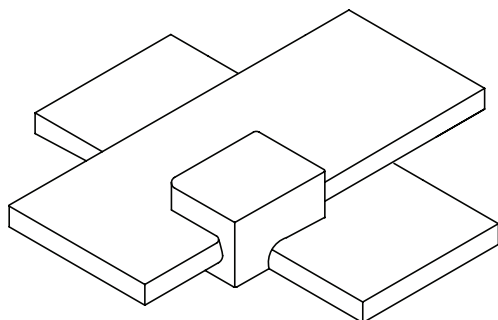

EB

EB

BUSBAR (mm)	MOULD PART NO.	WELDING MATERIAL ¹
3X25	EB C CAJ	115
3X30	EB C CAK	115
3X50	EB C CAM	200
4X40	EB C EAL	200
4X50	EB C EAM	250
5X40	EB C FAL	250
5X50	EB C FAM	250
6X25	EB C PAJ	200
6X50	EB C PAM	200

¹For Cadweld Plus add suffix "PLUSF20" (refer page 8)

BUSBAR TO BUSBAR

Horizontal X - bars flat and in same plane

• **Bold letter** in mould part number is the price key.

REQUIRED TOOLS

	Article No.	Part No.
Handle Clamps		
for C Price Key Moulds	161000	L160
for D Price Key Moulds	161020	L159
Cadweld Plus Control Unit or	165738	PLUSCU
Flint Ignitor	165000	T320

SUGGESTED TOOLS

Conductor Cleaning Brush	165130	T313
Slag Removal Spade		
#65 w/m & smaller	182125	B136A
#90 w/m & larger	182130	B136B
Mould Cleaning Brush	165260	T394
Cable Clamp	165020	B265
Torch Head	140160	T111

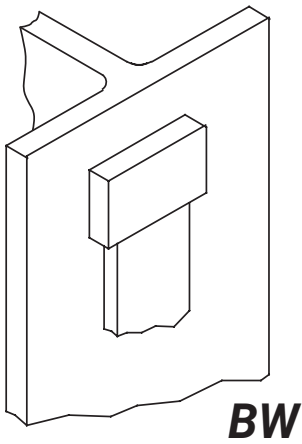

BW

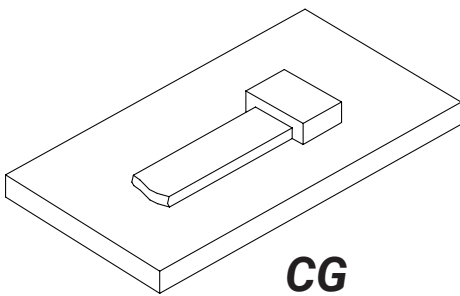

CG

BUSBAR TO BUSBAR

BW - Vertical rising copper busbar to a flat, vertical steel surface

CG - Horizontal tee - tap of copper busbar to busbar run

- A test weld should be made to check the possibility of burn through when intended for use on thin sections or thin wall pipe.

- **Bold letter** in mould part number is the price key.

REQUIRED TOOLS

	Article No.	Part No.
Handle Clamps		
for C Price Key Moulds	161000	L160
for D Price Key Moulds	161020	L159
Cadweld Plus Control Unit or	165738	PLUSCU
Flint Ignitor	165000	T320

SUGGESTED TOOLS

Conductor Cleaning Brush	165130	T313
Slag Removal Spade		
#65 w/m & smaller	182125	B136A
#90 w/m & larger	182130	B136B
Mould Cleaning Brush	165260	T394
Cable Clamp	165020	B265
Torch Head	140160	T111
Rasp	162420	T321

BW

BUSBAR SIZE	MOULD PART NO.	WELDING MATERIAL ¹
3X25	BW C CAJ	90
3X50	BW C CAM	150
4X40	BW C EAL	200
4X50	BW C EAM	250
5X40	BW C FAL	200
5X50	BW D FAM	250
6X25	BW C PAJ	150
6X50	BW D PAM	2 x 150*

¹For Cadweld Plus add suffix "PLUSF20" (refer page 8)

*For Cadweld Plus use 300PLUSF20

CG

BUSBAR SIZE	MOULD PART NO.	WELDING MATERIAL ¹
3X25	CG C CAJ	115
3X50	CG C CAM	200
4X25	CG C EAJ	150
4X50	CG C EAM	250
5X40	CG C FAL	200
5X50	CG C FAM	250
6X25	CG C PAJ	150
6X50	CG C PAM	300

¹For Cadweld Plus add suffix "PLUSF20" (refer page 8)

Cable to Busbar Tape

LJ

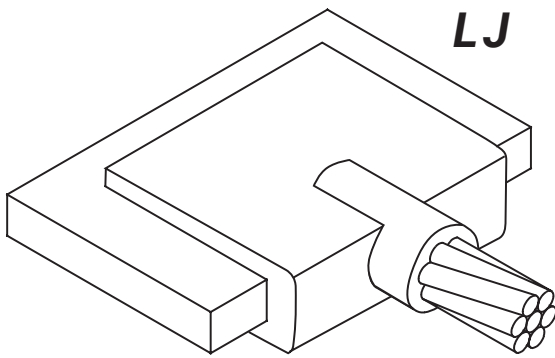

LJ

BUSBAR (mm)	CABLE SIZE (sq mm)	MOULD PART NO.	WELDING MATERIAL ¹
3 x 25	35	LJ CCA JY2	45
	50	LJ CCA JY3	90
	70	LJ CCA JY4	90
4 x 40 & WIDER	35	LJ CEA LY2	45
	50	LJ CEA LY3	90
	70	LJ CEA LY4	90
	95	LJ CEA LY5	90
	120	LJ CEA LY6	90
	150	LJ CEA LY7	115
	185	LJ CEA LY8	150
	240	LJ CEA LY9	150
	5 x 40 & WIDER	35	LJ CFA LY2
50		LJ CFA LY3	90
70		LJ CFA LY4	90
95		LJ CFA LY5	90
120		LJ CFA LY6	115
150		LJ CFA LY7	115
185		LJ CFA LY8	150
240		LJ CFA LY9	200
6 x 40 & WIDER		35	LJ CPA LY2
	50	LJ CPA LY3	90
	70	LJ CPA LY4	90
	95	LJ CPA LY5	90
	120	LJ CPA LY6	115
	150	LJ CPA LY7	115
	185	LJ CPA LY8	150
	240	LJ CPA LY9	200

¹For Cadweld Plus add suffix "PLUSF20" (refer page 8)

CABLE TO BUSBAR

Tap of horizontal cable to edge of horizontal, flat busbar.

- Concentric stranded copper cable is listed.
- The minimum distance between adjacent welds is indicated as "C" dimension.
- **Bold letter** in mould part number is the price key.

REQUIRED TOOLS

	Article No.	Part No.
Handle Clamps		
for C Price Key Moulds	161000	L160
for D Price Key Moulds	161020	L159
Cadweld Plus Control Unit or	165738	PLUSCU
Flint Ignitor	165000	T320

SUGGESTED TOOLS

	Article No.	Part No.
Conductor Cleaning Brush	165130	T313
Slag Removal Spade		
#65 w/m & smaller	182125	B136A
#90 w/m & larger	182130	B136B
Mould Cleaning Brush	165260	T394
Cable Clamp	165020	B265
Torch Head	140160	T111

Copper Lugs

LA

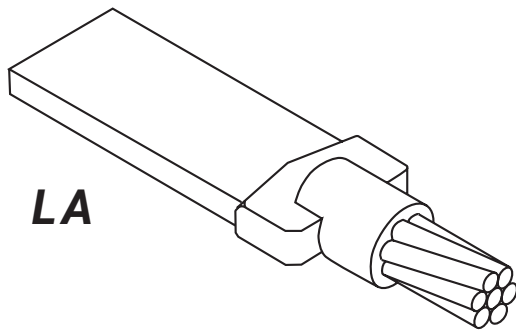

LA

CABLE SIZE (sq mm)	BUS OR LUG SIZE (mm)	MOULD PART NO.	WELDING MATERIAL ¹
16	2 x 20	LAC-W3-BAH	32
	2 x 25	LAC-W3-BAJ	32
	3 x 20	LAC-W3-CAH	45
	3 x 25	LAC-W3-CAJ	45
25	2 x 25	LAC-Y1-BAJ	45
	3 x 20	LACY1-CAH	45
	3 x 25	LAC-Y1-CAJ	45
	4 x 25	LAC-Y1-EAJ	65
35	2 x 25	LAC-Y2-BAJ	45
	3 x 20	LACY2-CAH	45
	3 x 25	LAC-Y2-CAJ	45
	4 x 25	LAC-Y2-EAJ	45
50	2 x 25	LAC-Y3-BAJ	45
	3 x 20	LAC-Y3-CAH	45
	3 x 25	LAC-Y3-CAJ	45
	4 x 25	LAC-Y3-EAJ	65
70	3 x 25	LAC-Y4-CAJ	65
	3 x 30	LAC-Y4-CAK	65
	4 x 25	LAC-Y4-EAJ	65
	4 x 30	LAC-Y4-EAK	65
	5 x 30	LAC-Y4-FAK	90
95	3 x 25	LAC-Y5-CAJ	65
	3 x 30	LAC-Y5-CAK	90
	4 x 25	LAC-Y5-EAJ	90
	4 x 30	LAC-Y5-EAK	90
	5 x 30	LAC-Y5-FAK	90
120	3 x 25	LAC-Y6-CAJ	90
	3 x 30	LAC-Y6-CAK	90
	4 x 25	LAC-Y6-EAJ	90
	4 x 30	LAC-Y6-EAK	90
	5 x 30	LAC-Y6-FAK	90

¹For Cadweld Plus add suffix "PLUSF20" (refer page 8)

COPPER LUGS (METRIC)

- Lugs and connections for equipment and structures. Ideal for power utility applications.
- Concentric stranded copper cable is listed.
- **Bold letter** in mould part number is the price key.

REQUIRED TOOLS

	Article No.	Part No.
Handle Clamps		
for C Price Key Moulds	161000	L160
for D Price Key Moulds	161020	L159
Cadweld Plus Control Unit or	165738	PLUSCU
Flint Ignitor	165000	T320

SUGGESTED TOOLS

Conductor Cleaning Brush	165130	T313
Slag Removal Spade		
#65 w/m & smaller	182125	B136A
#90 w/m & larger	182130	B136B
Mould Cleaning Brush	165260	T394
Cable Clamp	165020	B265
Torch Head	140160	T111

Copper Lugs

GL

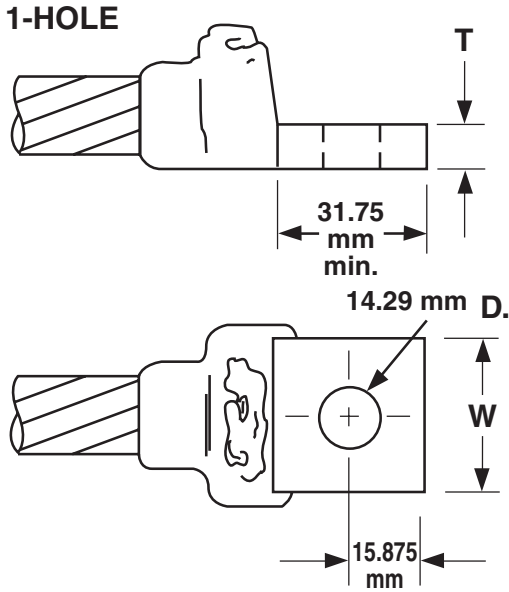
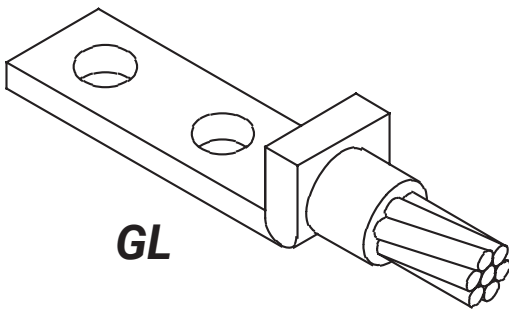

NEMA® Drilled Lugs-B-121 Series

All lugs are tin plated copper.

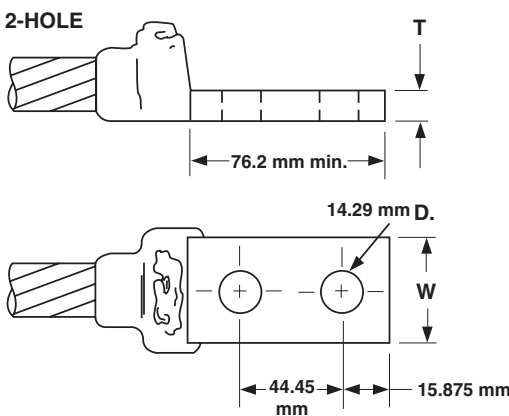

NEMA Drilled Lugs-B-122 Series

COPPER LUGS

- Lugs and connections for equipment and structures. Ideal for power applications.
- Concentric stranded copper cable is listed.
- **Bold letter** in mould part number is the price key.

REQUIRED TOOLS

	Article No.	Part No.
Handle Clamps		
for C Price Key Moulds	161000	L160
for D Price Key Moulds	161020	L159
Cadweld Plus Control Unit or	165738	PLUSCU
Flint Ignitor	165000	T320

SUGGESTED TOOLS

Conductor Cleaning Brush	165130	T313
Slag Removal Spade		
#65 w/m & smaller	182125	B136A
#90 w/m & larger	182130	B136B
Mould Cleaning Brush	165260	T394
Cable Clamp	165020	B265
Torch Head	140160	T111

GL

CABLE SIZE (sq mm)	MOULD PART NO.	WELDING MATERIAL ¹	LUG SIZE T X W (mm)	GL LUG NUMBER	
				1 HOLE	2 HOLE
25	GL C CEY1	32	3.18 x 25.4	B-121-CE	B-122-CE
35	GL C CEY2	32	3.18 x 25.4	B-121-CE	B-122-CE
50	GL C CEY3	45	3.18 x 25.4	B-121-CE	B-122-CE
70	GL C CEY4	45	3.18 x 25.4	B-121-CE	B-122-CE
95	GL C DEY5	65	4.76 x 25.4	B-121-DE	B-122-DE
120	GL C DEY6	65	4.76 x 25.4	B-121-DE	B-122-DE
150	GL C EEY7	90	6.35 x 25.4	B-121-EE	B-122-EE
185	GL C EEY8	90	6.35 x 25.4	B-121-EE	B-122-EE
240	GL C EGY9	150	6.35 x 38.1	B-121-EG	B-122-EG

¹For Cadweld Plus add suffix "PLUSF20" (refer page 8)

Cable to Ground Rod

GR

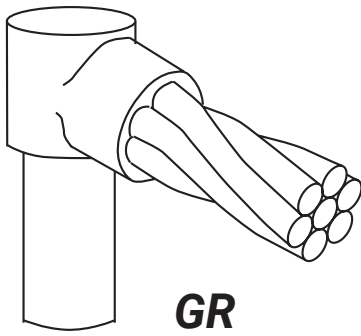

GR

GROUND ROD SIZE Dia. (mm)	CABLE SIZE (sq mm)	MOULD PART NO.	WELDING MATERIAL ¹
12.7	25	GR C P128Y1	65
	35	GR C P128Y2	65
	50	GR C P128Y3	65
	70	GR C P128Y4	90
	95	GR C P128Y5	90
	120	GR C P128Y6	90
	150	GR C P128Y7	115
	185	GR C P128Y8	115
14.2	25	GR C P143Y1	65
	35	GR C P143Y2	90
	50	GR C P143Y3	90
	70	GR C P143Y4	90
	95	GR C P143Y5	90
	120	GR C P143Y6	90
	150	GR C P143Y7	115
	185	GR C P143Y8	150
	240	GR C P143Y9	250
17.2	25	GR C P173Y1	90
	35	GR C P173Y2	90
	50	GR C P173Y3	90
	70	GR C P173Y4	90
	95	GR C P173Y5	90
	120	GR C P173Y6	90
	150	GR C P173Y7	115
	185	GR C P173Y8	115
	240	GR C P173Y9	150

¹For Cadweld Plus add suffix "PLUSF20" (refer page 8)

CABLE TO GROUND ROD

- Single cable to top of ground rod. Concentric strand copper cable unless otherwise noted. For copperclad, galvanized, stainless clad or stainless steel ground rods.
- **Bold letter** in mould part number is the price key.

REQUIRED TOOLS

	Article No.	Part No.
Handle Clamps		
for C Price Key Moulds	161000	L160
for D Price Key Moulds	161020	L159
Cadweld Plus Control Unit or	165738	PLUSCU
Flint Ignitor	165000	T320

SUGGESTED TOOLS

Conductor Cleaning Brush	165130	T313
Slag Removal Spade		
#65 w/m & smaller	182125	B136A
#90 w/m & larger	182130	B136B
Mould Cleaning Brush	165260	T394
Cable Clamp	165020	B265
File	165260	T329
Torch Head	140160	T111

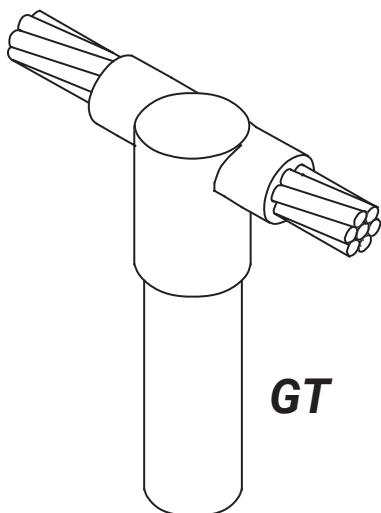

GT

GT

GROUND ROD SIZE Dia. (mm)	CABLE SIZE (sq mm)	MOULD PART NO.	WELDING MATERIAL ¹
12.7	25	GT CP 128Y1	90
	35	GT CP 128Y2	90
	50	GT CP 128Y3	90
	70	GT CP 128Y4	90
	95	GT CP 128Y5	115
	120	GT CP 128Y6	150
	150	GT CP 128Y7	150
	185	GT CP 128Y8	200
14.2	25	GT CP 143Y1	90
	35	GT CP 143Y2	90
	50	GT CP 143Y3	90
	70	GT CP 143Y4	115
	95	GT CP 143Y5	115
	120	GT CP 143Y6	150
	150	GT CP 143Y7	200
	185	GT CP 143Y8	200
17.2	240	GT CP 143Y9	250
	25	GT CP 173Y1	90
	35	GT CP 173Y2	90
	50	GT CP 173Y3	90
	70	GT CP 173Y4	115
	95	GT CP 173Y5	115
	120	GT CP 173Y6	150
	150	GT CP 173Y7	200
185	GT CP 173Y8	200	
240	GT CP 173Y9	250	

¹For Cadweld Plus add suffix "PLUSF20" (refer page 8)

CABLE TO GROUND ROD

- Through cable to top of ground rod. Connections are for concentric strand copper cable unless otherwise noted. For copperclad, galvanized, stainless clad or stainless steel ground rods.
- **Bold letter** in mould part number is the price key.

REQUIRED TOOLS

	Article No.	Part No.
Handle Clamps		
for C Price Key Moulds	161000	L160
for D Price Key Moulds	161020	L159
Cadweld Plus Control Unit or	165738	PLUSCU
Flint Ignitor	165000	T320

SUGGESTED TOOLS

Conductor Cleaning Brush	165130	T313
Slag Removal Spade		
#65 w/m & smaller	182125	B136A
#90 w/m & larger	182130	B136B
Mould Cleaning Brush	165260	T394
Cable Clamp	165020	B265
File	165260	T329
Torch Head	140160	T111

Cable/Tape to Ground Rod

GY/LQ

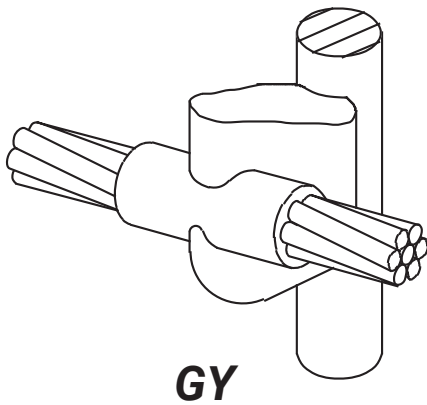

GY

GROUND ROD SIZE Dia. (mm)	CABLE SIZE (sq mm)	MOULD PART NO.	WELDING MATERIAL ¹
12.7	25	GY RP 128Y1	90
	35	GY RP 128Y2	90
	50	GY RP 128Y3	115
	70	GY RP 128Y4	115
	95	GY RP 128Y5	150
	120	GY RP 128Y6	150
	150	GY RP 128Y7	200
	185	GY RP 128Y8	200
14.2	25	GY RP 143Y1	90
	35	GY RP 143Y2	90
	50	GY RP 143Y3	115
	70	GY RP 143Y4	115
	95	GY RP 143Y5	150
	120	GY RP 143Y6	150
	150	GY RP 143Y7	200
	185	GY RP 143Y8	250
	240	GY FP 143Y9	2 x 200*
17.2	25	GY RP 173Y1	90
	35	GY RP 173Y2	90
	50	GY RP 173Y3	115
	70	GY RP 173Y4	150
	95	GY RP 173Y5	150
	120	GY RP 173Y6	250
	150	GY RP 173Y7	250
	185	GY FP 173Y8	2 x 200*
	240	GY FP 173Y9	2 x 200*

¹For Cadweld Plus add suffix "PLUSF20" (refer page 8)
 *For Cadweld Plus use 400PLUSF20

CABLE TO GROUND ROD

- Through cable to side of ground rod.
- Concentric strand copper cable unless otherwise noted.
- Ground rods can be copperclad, galvanized, stainless clad or stainless steel.
- **Bold letter** in mould part number is the price key.

REQUIRED TOOLS

	Article No.	Part No.
Handle Clamps		
for C Price Key Moulds	161000	L160
for D Price Key Moulds	161020	L159
Cadweld Plus Control Unit or	165738	PLUSCU
Flint Ignitor	165000	T320

SUGGESTED TOOLS

Conductor Cleaning Brush	165130	T313
Slag Removal Spade		
#65 w/m & smaller	182125	B136A
#90 w/m & larger	182130	B136B
Mould Cleaning Brush	165260	T394
Cable Clamp	165020	B265
File	165260	T329
Torch Head	140160	T111

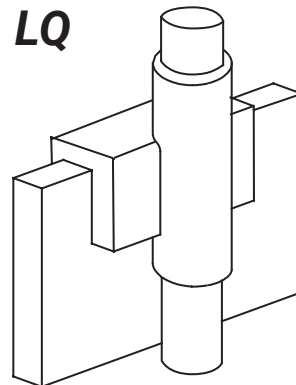

LQ

GROUND ROD SIZE Diam. (mm)	BUSBAR SIZE (mm)	MOULD PART NO.	WELDING MATERIAL ¹
12.7	3 x 25	LQ E -P128-CAJ	200
14.2	3 x 25	LQ E -P143-CAJ	200
17.2	3 x 25	LQ E -P173-CAJ	2 x 200*

¹For Cadweld Plus add suffix "PLUSF20" (refer page 8)
 *For Cadweld Plus use 400PLUSF20

Tape to Ground Rod

CP/CN

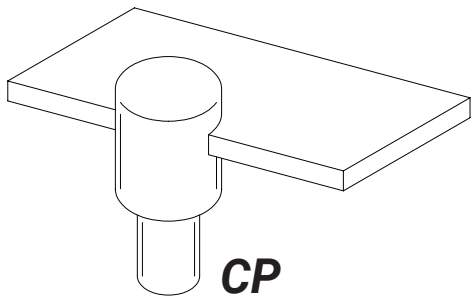

CP

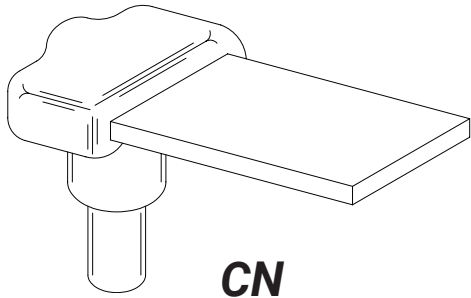

CN

CP

GROUND ROD SIZE (sq mm dia)	BUSBAR (mm)	MOULD PART NO.	WELDING MATERIAL
12.7		C PC P128BAK	115
14.2	2 x 30	C PC P148BAK	115
17.2		C PC P178BAK	115
12.7		C PC P128CAJ	150
14.2	3 x 25	C PC P142CAJ	115
17.2		C PC P172CAJ	200
12.7		C PC P128PAM	150
14.2	6 x 50 (or wider)	C PC P142PAM	200
17.2		C PC P172PAM	250

CN

GROUND ROD SIZE (sq mm dia)	BUSBAR (mm)	MOULD PART NO.	WELDING MATERIAL
12.7		C NC P128BAK	115
14.2	2 x 30	C NC P148BAK	115
17.2		C NC P178BAK	150
12.7		C NC P128CAJ	90
14.2	3 x 25	C NC P142CAJ	150
17.2		C NC P172CAJ	150
12.7		C NC P128PAM	200
14.2	6 x 50 (or wider)	C NC P142PAM	250
17.2		C NC P172PAM	2 x 150*

*For Cadweld Plus use 300PLUSF20

BUSBAR TO GROUND ROD

TYPE CP - Through busbar to top of ground rod.

TYPE CN - Busbar tap to top of ground rod.

• Ground rods can be copperbonded, copperclad, galvanized, stainless steel or stainless steel clad.

• **Bold letter** in mould part number is the price key.

REQUIRED TOOLS

	Article No.	Part No.
Handle Clamps		
for C Price Key Moulds	161000	L160
for D Price Key Moulds	161020	L159
Cadweld Plus Control Unit or	165738	PLUSCU
Flint Ignitor	165000	T320

SUGGESTED TOOLS

Conductor Cleaning Brush	165130	T313
Slag Removal Spade		
#65 w/m & smaller	182125	B136A
#90 w/m & larger	182130	B136B
Mould Cleaning Brush	165260	T394
Cable Clamp	165020	B265
Torch Head	140160	T111

Cable to Ground Rod Cadweld One Shot

GR/GT

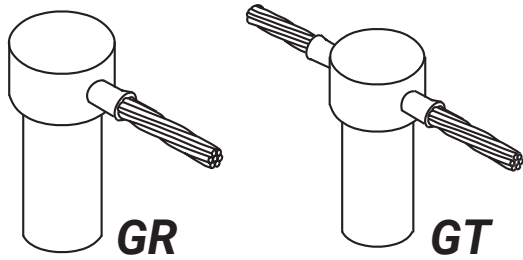

Cadweld One Shot connections are available in standard packages of 6 each.

GROUND ROD SIZE Dia. (mm)	CONDUCTOR SIZE (mm ²)	PART NUMBER	
		TYPE GR ¹	TYPE GT ¹
12.7	8-10	GR1-141G	GT1 -141G
	14-22	GR1-141L	GT1 -141L
	25	GR1-141Q	GT1-141Q
	30-38	GR1-141V	GT1 -141V
14.2	8-10	GR1-161G	GT1-161G
	14-22	GR1-161L	GT1-161L
	25	GR1-161Q	GT1-161Q
	30-38	GR1-161V	GT1-161V
	50-60	GR1-162C	GT1-162C
17.2	70 sq mm	GR1-162G	GT1-162C
	8-10	GR1-181G	GT1-181G
	14-22	GR1-181L	GT1-181L
	25	GR1-181Q	GT1-181Q
	30-38	GR1-181V	GT1-181V
	50-60	GR1-182C	GT1-182C
	70 sq mm	GR1-182G	GT1-182C

¹For Cadweld Plus One Shot add suffix "PLUS" following the above part number

CABLE TO GROUND ROD USING CADWELD ONE SHOT CONNECTIONS

For both plain or threaded copperclad and galvanized steel or stainless steel rods. The Cadweld One Shot case is a ceramic disposable body replacing the familiar semi-permanent graphite mould and associated handle clamp. Everything required is included except control unit. Meets NEC® requirements

REQUIRED TOOLS

	Article No.	Part No.
Cadweld Plus Control Unit or	165738	PLUSCU
Flint Ignitor	165000	T320

SUGGESTED TOOLS

Cable Cleaning Brush	165030	T313
File	165260	T329
Torch Head	140160	T111



GB

GROUND ROD SPLICE

- Cadweld ground rod splices are very strong and use the proven corrosion resistant Cadweld connection.
- Cadweld ground rod splices are available for copperclad, galvanized or stainless ground rods.
- **Bold letter** in mould part number is the price key.

REQUIRED TOOLS

	Article No.	Part No.
Handle Clamps		
for C Price Key Moulds	161000	L160
for D Price Key Moulds	161020	L159
Cadweld Plus Control Unit or	165738	PLUSCU
Flint Ignitor	165000	T320
Ground Rod Splice Clamp		B120

SUGGESTED TOOLS

Conductor Cleaning Brush	165130	T313
Slag Removal Spade		
#65 w/m & smaller	182125	B136A
#90 w/m & larger	182130	B136B
Mould Cleaning Brush	165260	T394
Cable Clamp	165020	B265
File	165260	T329
Torch Head	140160	T111

GB

GROUND ROD SIZE Dia. (mm)	MOULD PART NO.	WELDING MATERIAL
12.7	HDGB C 14	250*
14.2	HDGB C 16	2 x 150**
17.2	HDGB C 18	2 x 200***

*For Cadweld Plus use 250PLUSF20

**For Cadweld Plus use 300PLUSF20

***For Cadweld Plus use 400PLUSF20

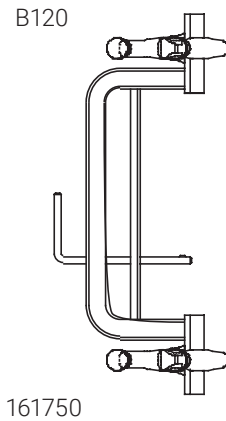

Ground Rod Splice Clamp

The B120 Ground Rod Splice Clamp must be used to support the upper rod and provide a method of correctly positioning the rods and mould while splicing the rods. (Type HDGB Connection).

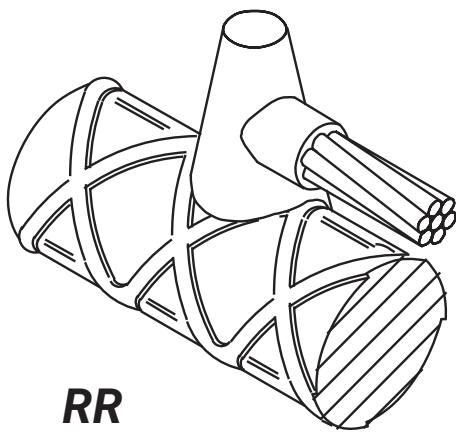

CABLE TO REBAR

Horizontal cable tap to horizontal rebar.

- Rebar material characteristics and location of weld must be considered when selecting connections to rebar.
- Concentric stranded copper cable is listed.
- **Bold letter** in mould part number is the price key.

REQUIRED TOOLS

	Article No.	Part No.
Handle Clamps		
for C Price Key Moulds	161000	L160
for D Price Key Moulds	161020	L159
Cadweld Plus Control Unit or	165738	PLUSCU
Flint Ignitor	165000	T320
Packing Material	One required for each connection - see tables below	

SUGGESTED TOOLS

Cable Cleaning Brush	165030	T313
Slag Removal Spade		
#65 w/m & smaller	182125	B136A
#90 w/m & larger	182130	B136B
Mould Cleaning Brush	165260	T394
File	165260	T329
Torch Head	140160	T111

RR

REBAR SIZE Diam (mm)	CABLE SIZE (sq mm)	MOULD PART NO.	WELDING MATERIAL ¹	PACKING MATERIAL
12	25	RR A 52Y1	45	B143A
	35	RR A 52Y2	45	B143A
	50	RR C 52Y3	90	B141A
	70	RR C 52Y4	90	B141A
	95	RR C 52Y5	115	B141A
16	25	RR A 53Y1	45	B143A
	35	RR A 53Y2	45	B143A
	50	RR C 53Y3	90	B141A
	70	RR C 53Y4	90	B141A
	95	RR C 53Y5	115	B141A

¹For Cadweld Plus add suffix "PLUSF20" (refer page 8)

REBAR SIZE Diam (mm)	CABLE SIZE (sq mm)	MOULD PART NO.	WELDING MATERIAL ¹	PACKING MATERIAL
22	35	RR A 55Y2	45	B143B
	50	RR H 55Y3	90	B144C
	70	RR H 55Y4	90	B144C
	95	RR H 55Y5	115	B144A
	25	35	RR A 56Y2	45
50		RR H 56Y3	90	B144C
70		RR H 56Y4	90	B144C
95		RR H 56Y5	115	B144A
32		50	RR H 58Y3	90
	70	RR H 58Y4	90	B144C
	95	RR H 58Y5	115	B144A

¹For Cadweld Plus add suffix "PLUSF20" (refer page 8)

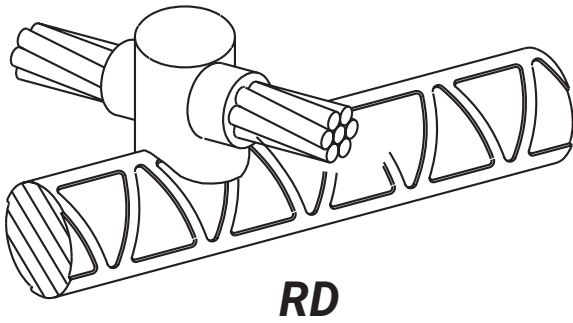

CABLE TO REBAR

X-connection horizontal cable to horizontal rebar.

- Rebar material characteristics and location of weld must be considered when selecting connections to rebar.
- Concentric stranded copper cable is listed.
- **Bold letter** in mould part number is the price key.

REQUIRED TOOLS

	Article No.	Part No.
Handle Clamps		
for C Price Key Moulds	161000	L160
for D Price Key Moulds	161020	L159
Cadweld Plus Control Unit or	165738	PLUSCU
Flint Ignitor	165000	T320
Packing Material	One required for each connection - see tables below	

SUGGESTED TOOLS

Cable Cleaning Brush	165030	T313
Slag Removal Spade		
#65 w/m & smaller	182125	B136A
#90 w/m & larger	182130	B136B
Mould Cleaning Brush	165260	T394
File	165260	T329
Torch Head	140160	T111

RD

REBAR SIZE Diam (mm)	CABLE SIZE (sq mm)	MOULD PART NO.	WELDING MATERIAL ¹	PACKING MATERIAL
12	25	RDC52Y1	65	B141A
	35	RDC52Y2	90	B141A
	50	RDM52Y3	115	B141A
	70	RDM52Y4	115	B141A
	95	RDM52Y5	150	B141A
16	25	RDC53Y1	65	B141A
	35	RDC53Y2	90	B141A
	50	RDM53Y3	115	B141A
	70	RDM53Y4	115	B141A
	95	RDM53Y5	150	B141A

¹For Cadweld Plus add suffix "PLUSF20" (refer page 8)

REBAR SIZE Diam (mm)	CABLE SIZE (sq mm)	MOULD PART NO.	WELDING MATERIAL ¹	PACKING MATERIAL
22	35	RD H 55Y2	90	B144C
	50	RD H 55Y3	115	B144C
	70	RD H 55Y4	115	B144C
	95	RD H 55Y5	150	B144A
	25	35	RD H 56Y2	90
50		RD H 56Y3	115	B144C
70		RD H 56Y4	115	B144C
95		RD H 56Y5	150	B144A
32		50	RD H 58Y3	115
	70	RD H 58Y4	115	B144C
	95	RD H 58Y5	150	B144A

¹For Cadweld Plus add suffix "PLUSF20" (refer page 8)

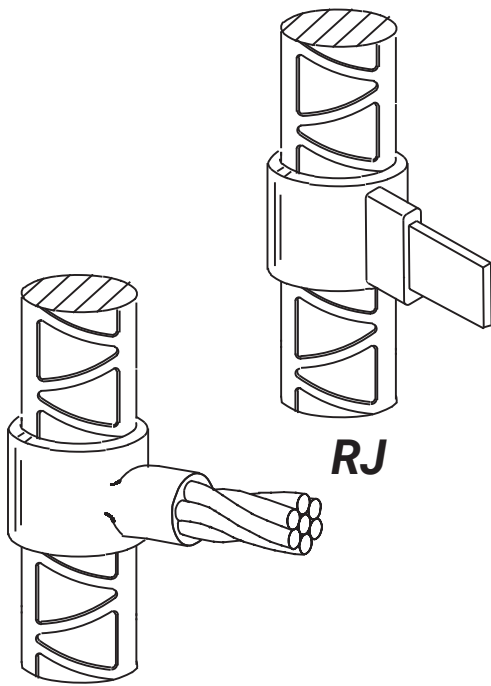

CABLE / BUSBAR TO REBAR

Horizontal tee - tap of cable or busbar to vertical rebar.

- Rebar material characteristics and location of weld must be considered when selecting connections to rebar.
- Concentric stranded copper cable is listed.
- **Bold letter** in mould part number is the price key.

REQUIRED TOOLS

	Article No.	Part No.
Handle Clamps		
for C&E Price Key Moulds	161000	L160
for D Price Key Moulds	161020	L159
Cadweld Plus Control Unit or	165738	PLUSCU
Flint Ignitor	165000	T320
Packing Material	One required for each connection - see tables below	

SUGGESTED TOOLS

Cable Cleaning Brush	165030	T313
Slag Removal Spade		
#65 w/m & smaller	182125	B136A
#90 w/m & larger	182130	B136B
Mould Cleaning Brush	165260	T394
File	165260	T329
Torch Head	140160	T111

RJ

REBAR SIZE Diam (mm)	CABLE SIZE (sq mm)	MOULD PART NO.	WELDING MATERIAL ¹	PACKING MATERIAL
12	25	RJ C 52Y1	65	B140A
	35	RJ C 52Y2	65	B140A
	50	RJ C 52Y3	115	B140A
	70	RJ C 52Y4	115	B140A
	95	RJ C 52Y5	150	B140A
16	25	RJ C 53Y1	65	B140A
	35	RJ C 53Y2	65	B140A
	50	RJ C 53Y3	115	B140A
	70	RJ C 53Y4	115	B140A
	95	RJ C 53Y5	150	B140A
22	35	RJ E 55Y2	65	B144E
	50	RJ E 55Y3	115	B144B
	70	RJ E 55Y4	115	B144B
	95	RJ E 55Y5	150	B144B
	25	35	RJ E 93Y2	65
50		RJ E 93Y3	115	B144B
70		RJ E 93Y4	115	B144B
95		RJ E 93Y5	150	B144B
32		50	RJ E 58Y3	115
	70	RJ E 58Y4	115	B144B
	95	RJ E 58Y5	150	B144E

¹For Cadweld Plus add suffix "PLUSF20" (refer page 8)

REBAR SIZE Diam (mm)	BUSBAR (MM)	MOULD PART NO.	WELDING MATERIAL ¹	PACKING MATERIAL
12		RJ C 52CAJ	200	B140A
16		RJ C 53CAJ	200	B140A
22	3 x 25	RJ E 55CAJ	250	B144B
25		RJ E 56CAJ	250	B144B
32		RJ E 58CAJ	250	B144B

¹For Cadweld Plus add suffix "PLUSF20" (refer page 8)

Note: All welds to rebar requiring larger than 150 g of welding material will be sold only after review by nVent.

Cadweld Cast Ground Plates

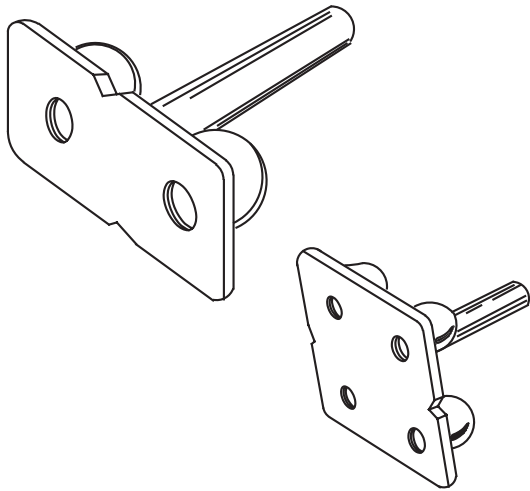

CADWELD CAST GROUND PLATES

Cadweld ground plates used in concrete structures offer convenient ground system connection points. These ground points are used for equipment, machinery and structure grounding after completion of the concrete work.

The castings are made from a copper alloy ...

Cadweld ground plate connections result in current carrying capacity equal to that of the conductor or stud and cannot loosen or corrode.

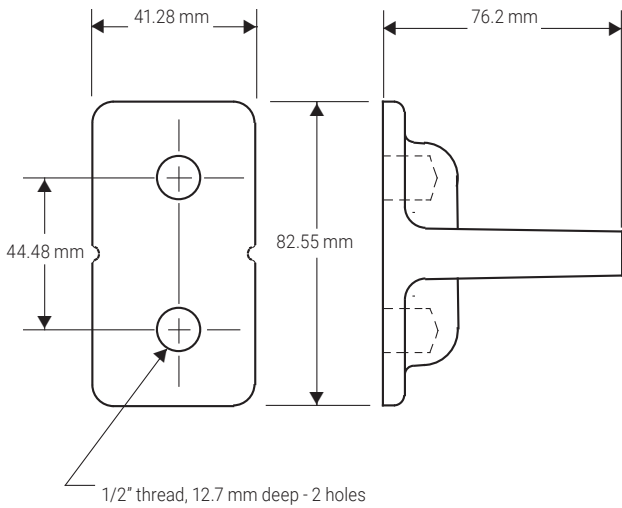

B162-2Q With stud to suit moulds for conductor 4/0 AWG (120 mm²)

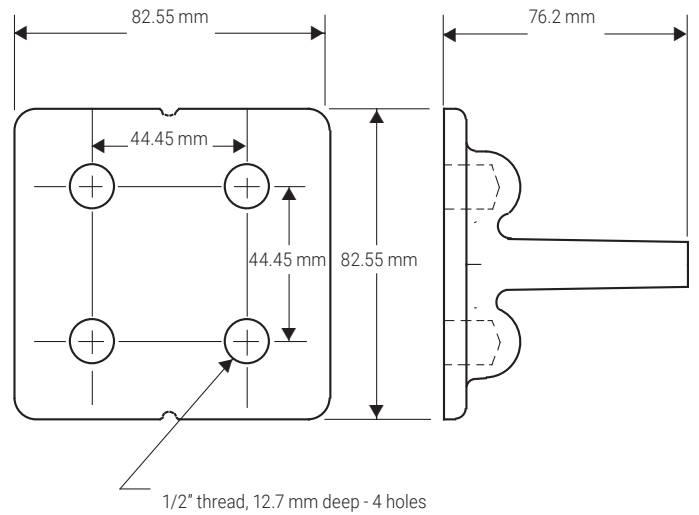

B164-2Q With stud to suit moulds for conductor 4/0 AWG (120 mm²)

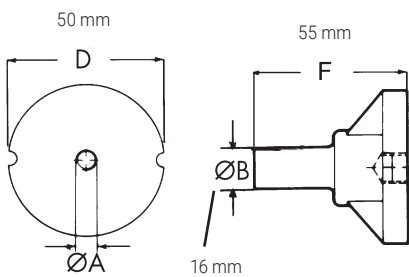

DB12A (Article No. 166150) complete with M12 Stud

CAUTION: Use only Cadweld cast ground plates. Other similar plates may be available that do not meet the strength requirements necessary. They may crack or break during installation.

Use a Cadweld Type TA or Type SS mould when connecting the Cadweld cast ground plate to the ground conductor. The cast ground plate stud size noted above fits the mould opening for a cable of the same size.

Example: Tee connection of 120 mm² cable to B164-2Q (4/0 AWG stud size), use mould TACY62Q.
Splice connection of 120 mm² cable to B164-2Q, use mould SSC-2QY6.

Aircraft Grounding Receptacles

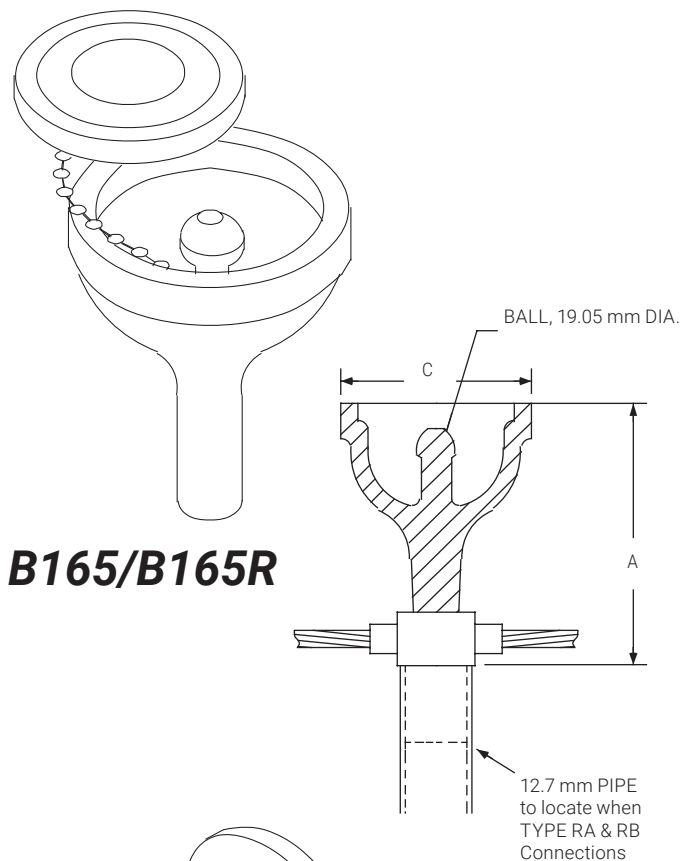

B-165 AND B-165R

The B-165 and B-165R Grounding Receptacles are copper alloy castings intended for use in static grounding systems of aircraft refueling areas. They are easily connected to the grounding system conductor and/or ground rods with Cadweld connections. Designed for simple installation flush with the paved surface. The attachment point (19.05mm ball) is an integral part of the casting on the B-165 and is removable on the B-165R.

RECEPTACLE

B-165 and B-165R

Depth A, Grade Level to Support. 114 mm

Diameter C, at Grade Level 70 mm

SPECIAL NOTE

Aircraft Static Grounding Clamp B2617A can be used to connect to B-166 and B-167

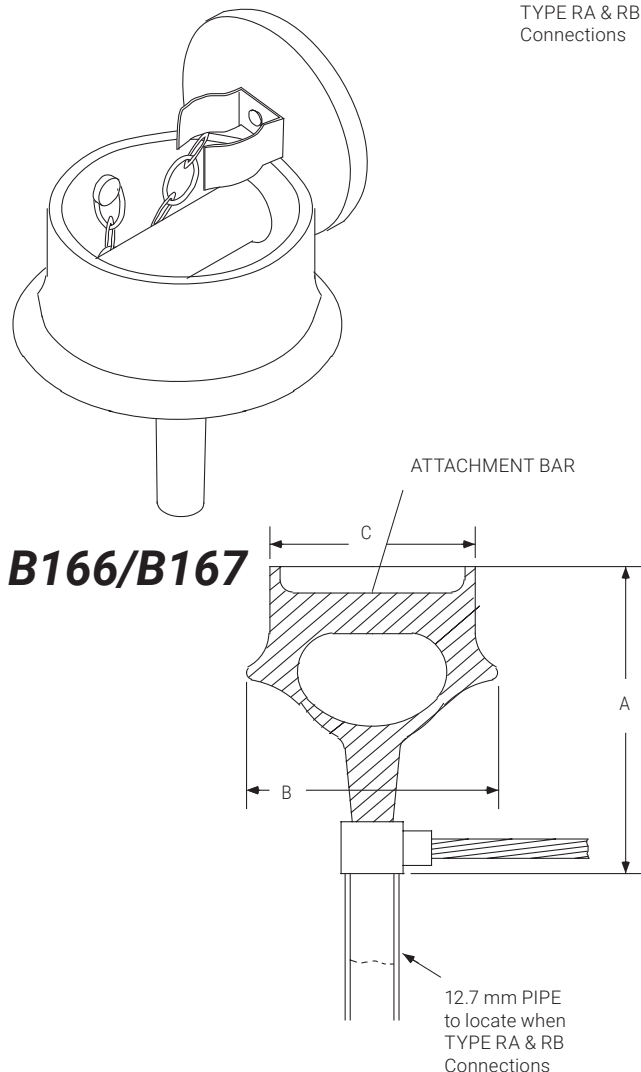

B-166 AND B-167

The B-166 and B-167 Combination Tie-down and Static Grounding Receptacles are copper alloy castings. They are easily connected to the grounding system conductor with Cadweld connections. Designed for simple installation flush with the paved surface. The attachment bar (19.05 mm diameter on the B-166 and 38.1 mm on the B-167) is an integral part of the casting.

RECEPTACLE

B-166

B-167

Depth A, Grade Level to Support

159

185

Diameter B, Maximum Ring Size

121

165

Diameter C, at Grade Level

98

121

For assemblies using B-166 and B-167, contact nVent ERICO.











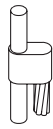
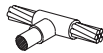
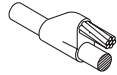
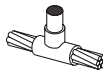
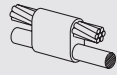
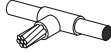

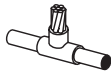
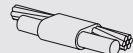
Other Cable to Cable Connections

The connections shown below are for use only where connections shown in this catalog are not suitable.

NAME	TYPE	EASE	SPLIT	NAME	TYPE	EASE	SPLIT			
Parallel dead end	PJ		1	V	Tee	TC		3	V	
	PK		2	*		TD		3	*	
	PM		3	V		TE		3	*	
	PN		3	V		TF		3	V	
Parallel Tap	PH		3	V		TL		3	V	
	PA		2	*		TV		3	V	
	PB		3	V		X vertical (horizontal cable uncut)	XC		3	V
	PC		1	V	X vertical (vertical cable uncut)		XD		3	V
	PD		3	V			X vertical (neither cable cut)	XF		3
	PG		1	V	XG				3	*
Splice	PP		1	*	X - 45° tap	YC		3	V	
	PQ		3	V		YD		3	V	
	PR		2	V		YE		3	V	
	SC		1	*						
	SD		3	V						
	SE		3	V						
	SV		3	V						

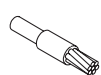
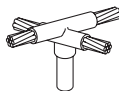

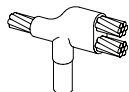
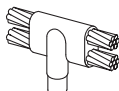

Other Cable to Ground Rods or Other Connections





The connections shown below are for use only where connections shown in this catalog are not suitable.

NAME	TYPE	EASE	SPLIT	NAME	TYPE	EASE	SPLIT		
Parallel tap	GQ		3	V	Tee	GG		1	*
	GS		1	V		GH		3	V
Parallel thru	DQ		1	V		GJ		1	*
	GP		3	V		GK		3	V
	GW		1	V		GM		2	V
Splice	GD		3	V		GN		2	V
	GE		1	V		GX		3	V
	GF		1	V		NB		4	*
	GV		1	V		NC		1	V
				ND			1	V	
				Y - 45° tap		VW		2	V

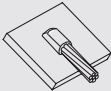
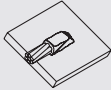
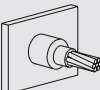

Other Cable to Steel or Cast Iron Connections

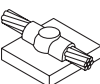

The connections shown below are for use only where connections shown in this catalog are not suitable.

NAME	TYPE	EASE	SPLIT
Tap cast iron	VH	1	V
			
	VJ	1	V
			
	VK	1	V
			
	VR	1	V
			

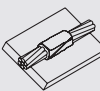
NAME	TYPE	EASE	SPLIT
Tap steel	HF	1	*
			
	HG	2	*
			
	VA	1	V
			
	VC	1	V
			
	VE	2	V
			
	VL	1	V
			

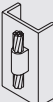

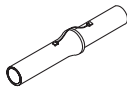
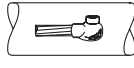
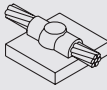
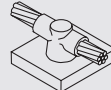

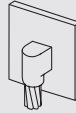
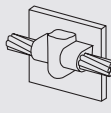
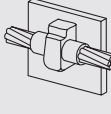
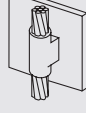





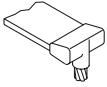

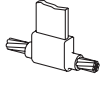
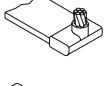
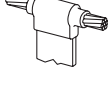

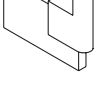





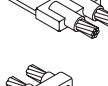
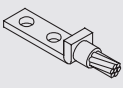

Thru cast iron	HE	1	*
			

Thru steel	HJ	2	*
			
	HK	1	V
			
	VX	2	V
			

NAME	TYPE	EASE	SPLIT
Pipe	HB	1	*
			
	VN	1	*
			
Other connections to steel	HC	1	*
			
	HT	1	V
			
	VF	1	V
			
	VB	2	V
			
	VG	1	V
			
	VT	1	
			
	VV	1	V
			

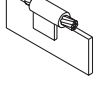

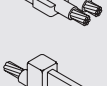



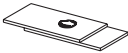
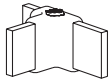

Other Cable to Busbar or Lug Connections

The connections shown below are for use only where connections shown in this catalog are not suitable.

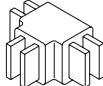
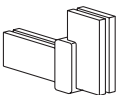
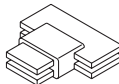

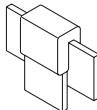
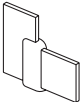
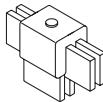
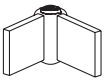
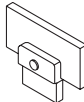
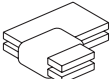
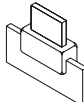
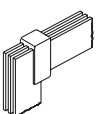
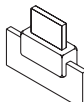
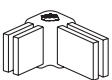
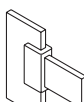
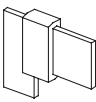
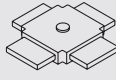
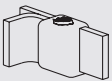
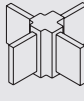
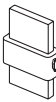
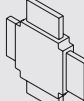

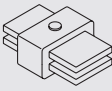



NAME	TYPE	EASE	SPLIT	NAME	TYPE	EASE	SPLIT		
EII	DN		2	V	Splice	LD		3	V
	LX		2	*		LF		3	*
	LY		3	*		LG		3	V
	MA		2	*		LH		3	*
	MB		3	*		LK		2	V
	MC		3	*		LL		1	V
	MD		3	*		LM		1	V
	ME		2	*		LN		4	*
	MF		3	*		LP		2	*
	MG		2	V		LS		2	*
Lug	PL		1	V	LT		2	*	
Parallel tap	LV		1	V	LQ		2	V	
Parallel thru	LW		1	V	Tee	LR		2	*
Splice	DM		2	*					
	DS		2	*					
	LB		1	V					
	LC		3	V					

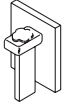
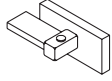
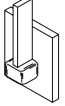
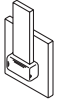
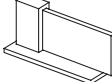

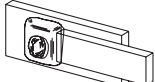



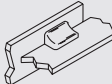
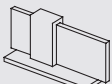

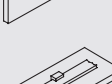





Other Busbar to Busbar Connections

The connections shown below are for use only where connections shown in this catalog are not suitable.

NAME	TYPE	EASE	SPLIT	NAME	TYPE	EASE	SPLIT		
Button-weld	TW		1	*	Tee	BK		2	*
	TX		1	V		BL		3	*
EII	DJ		4	V		BN		3	*
	EN		2	*		BR		2	V
	EQ		4	V		BS		2	V
	ER		2	*		BT		4	*
	ES		3	*		BV		3	*
	ET		2	V		DE		3	V
	EV		3	*		EE		3	V
	EP		1	V		X	EA		4
Parallel tap	BJ		2	V	EC			4	*
Splice	BC		3	V	ED			4	V
	BD		3	*					
	BF		2	*					
	BG		2	*					
	BH		4	V					



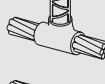
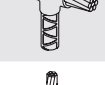
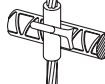
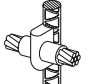







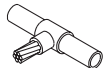

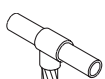

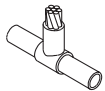
Other Busbar Connections / Other Rebar Connections

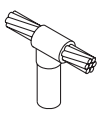
NAME	TYPE	EASE	SPLIT	
Tap	BX		3	V
	BY		3	V
	CA		3	V
	CB		2	V
	CJ		2	V
	DC		3	*
	DD		3	V
	DF		2	V
	HL		1	V
	HM		1	V
	HN		1	*
	Thru	CD		3
CK			2	V
CF			1	V
CC			1	V
CH			1	V

NAME	TYPE	EASE	SPLIT	
EII	DT		2	V
Parallel tap	DR		2	V
	RV		2	V
Parallel thru	RT		2	V
	RW		2	V
Splice	RE		2	V
	RF		2	V
	RG		1	V
	SF		2	V
	SR		1	V
	Tee	RH		1
RK			1	*
	RL		2	V
	RM		2	V
	RN		2	V
	RP		2	V
	RQ		2	V
X	XJ		1	*
	RC		1	V



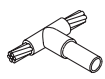

Cable to Copper Tube Connections

The connections shown below are for use only where connections shown in this catalog are not suitable.

NAME	TYPE	EASE	SPLIT	NAME	TYPE	EASE	SPLIT
EII	DP		1 *	Tee	ML		1 *
	MV		2 V		MM		3 *
	MW		3 V		MP		3 *
	MX		2 V		MQ		
	MY		3 V		MR		3 *
Splice	MH		1 V		MS		3 *
	MJ		3 V		MT		3 *
	MK		3 V		NA		1 *

Busbar to Ground Rods Connections

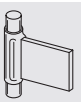
The connections shown below are for use only where connections shown in this catalog are not suitable.

NAME	TYPE	EASE	SPLIT	NAME	TYPE	EASE	SPLIT
EII	CL		1 V	Splice	CS		3 V
Tee	CM		3 V	Tee	CQ		3 V
					CR		1 V

Copper Tube to Ground Rods Connections

The connections shown below are for use only where connections shown in this catalog are not suitable.

NAME	TYPE	EASE	SPLIT	NAME	TYPE	EASE	SPLIT
EII	FT	1	V	EII	FT	1	V

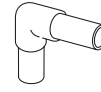
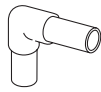

Copper Tube to Copper Tube Connections

The connections shown below are for use only where connections shown in this catalog are not suitable.

NAME	TYPE	EASE	SPLIT	NAME	TYPE	EASE	SPLIT
EII	FK	1	*	Tee	FH	3	V
	FL	3	V		FF	1	*
	FM	2	V		FG	2	V
Splice	FD1	V			FH	3	V
	FE	3	V		FJ	3	V
				X	XT	4	*

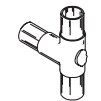
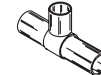
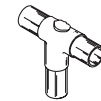
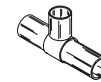
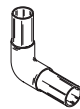

Copper Tube to Busbar or Lugs Connections

The connections shown below are for use only where connections shown in this catalog are not suitable.

NAME	TYPE	EASE	SPLIT	NAME	TYPE	EASE	SPLIT
Splice	FN	1	*	Tee	FR	2	*
	FP	1	V		FS	1	V
Tee	EW	2	V				

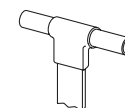
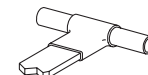
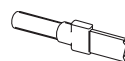
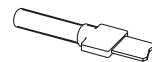

Material, Tools and Accessories

ADAPTING MOULDS TO FIT CONDUCTORS

Cables smaller than indicated on mould tag can be welded by using either Wrap Sleeve or Adapter Sleeves.

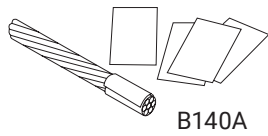

B140A

Cadweld Wrap Sleeve B140A

Cadweld Wrap Sleeve is wrapped around the cable until the diameter is about the same as the cable opening in the mould.

Cadweld Adapter Sleeves

Cadweld Adapter Sleeves are used to adapt a limited range of smaller size cables to a larger size Cadweld Mould.

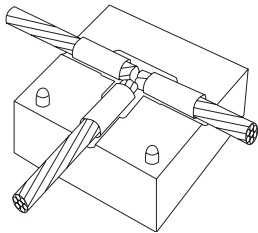

CABLE SIZE Concentric Strand	Adapter Sleeve Part No.	Use in Mould for Stranded
4	B-133-1H	10
10	B-133-1L	25
16	B-112	25
16	B-133-1V	35
25*	B-133-1Y	35
35	B-133-2C	50
35	B-133-2G	70
50	B-133-2L	70
70	B-133-2Q	95

*Substitute for 7/2.14 only

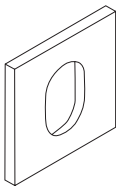

Packing

Packing consists of either preformed ceramic packing or sometimes B140A or B141A copper wrap shim. Packing is required on all rebar connections.



T403

Cadweld Mould Sealer

T403 Cadweld Mould Sealer is ideal for sealing hot or cold moulds to retard leakage from large stranded conductors. It is required on certain moulds such as Types HA, HB, HC, VG and VN. It prolongs useful mould life when the cable opening becomes worn.

It is available in a convenient 0.9 kg package.

Material, Tools and Accessories

CABLE AND WORK SURFACE PREPARATION

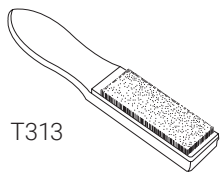

T313

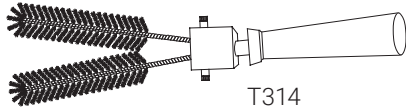

T314

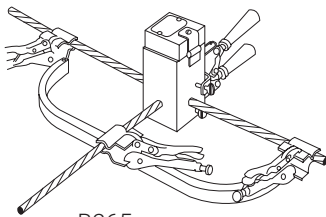

B265

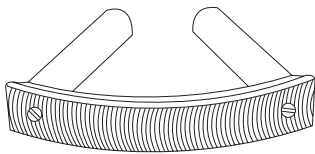

T321

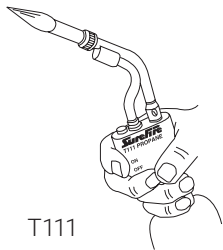

T111

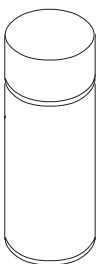

T372A

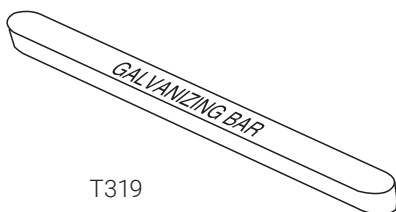

T319

CABLE CLEANING BRUSHES

Two types of brushes are available to aid in removing oxides and cleaning copper surfaces. T313 Card Cloth Brush with short stiff bristles is generally preferred for cleaning concentric conductors and busbars, which are not heavily oxidized.

T314 Cable Cleaning Brush cleans any conductor and is especially useful for coarse or very dirty conductors. The brushes can be rotated to provide new cleaning bristles and are replaceable.

CABLE CLAMP B265

The B265 Cable clamp should be used with hard drawn copper cable, Copperweld® DSA conductor or any cable under tension. Use of the clamp aids in preventing cable movement and prolongs mould life.

RASP

T321 rasp is used to remove rust from any steel surface or galvanizing from hot dipped galvanized steel to expose the bare steel for welding. The curved blade makes it an efficient tool for flat surfaces. T321A Replacement blades are also available.

SUREFIRE® TORCH HEAD

T111 Self igniting propane torch head. Squeeze the control knob for an instant flame. Release and it's out. No flame adjusting. The burn tip remains cool during normal use. Operates on its side or upside down. Can withstand 60 MPH winds without flareout. Fits all standard 14 and 16 oz. propane cylinders.

GALVANIZING TOUCH-UP

Easy to use galvanizing paint in a spray can is used to touch up heat affected areas on galvanized steel surfaces after welding. The damage to the galvanizing is often minimal so the repair is often cosmetic. T372A galvanizing compound available in 12 ounce aerosol can.

GALVANIZING BAR

T319 Galvanizing Bar is used to repair a galvanized surface that has been damaged by welding or drilling. This is a low temperature, self-fluxing material. Often there is sufficient heat after making the Cadweld Connection to melt the bar or a small torch may be used.

Material, Tools and Accessories

MOULD CARE AND USE

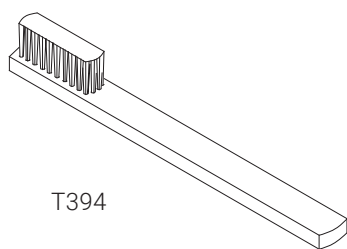

T394

MOULD CLEANING BRUSH

Mould cleaning brush T394 is very useful for removing slag from moulds – especially vertically split moulds.

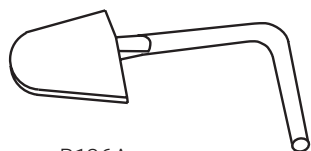

B136A
B136B

SLAG REMOVAL SPADES

Slag Removal Spades are useful for removing the slag after making a Cadweld Connection – especially useful with horizontally split moulds.

Slag Spade Part No.	Use With Mould Price	Using Welding Material Size
B-136-A	A,C, & R	#65 & Smaller
B-136-B	C,D,F & R	#90 & Larger

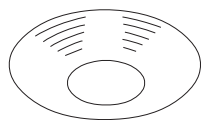

DISKS

Each time a weld is made, a new disk is required. The disk sits on the bottom of the crucible. Its purpose is to hold the welding material until the reaction takes place. The slag produced by the reaction rises to the surface and the molten copper settles to the bottom of the crucible where it melts the disk and melts through the conductors to produce a permanent molecular bond.

Disks are available in three sizes:

B117A used in moulds using #15 thru #32 welding material (3/4" diameter).

B117B used in moulds using #45 thru #115 welding material (1" diameter).

B117C used in moulds using #150 thru #500 welding material (1-1/2" diameter).

Disks are included with Welding Material.

DISK KIT

A disk container (T328) which includes 20 of each of the three sizes of steel disks is available for your convenience. Kit P/N T328D.

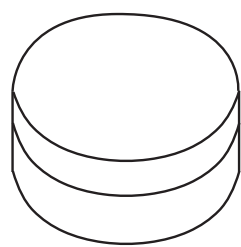

T328D

Material, Tools and Accessories

MOULD FASTENING AND MOUNTING

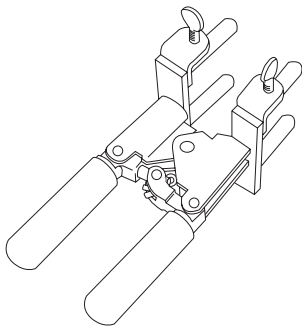

CADWELD HANDLE CLAMPS

Handle Clamps such as the one shown are required for most moulds. Specialized frames with handles are used on some moulds. Flint ignitors are included with all Handle Clamps. The following Handle Clamps are most widely used.

1. L160 for all moulds having a "C", "E", "Q", or "R" mould price key.
(3" wide moulds)
2. L159 for all moulds having a "D", "F", "J" or "Z" mould price key.
(4" wide moulds)

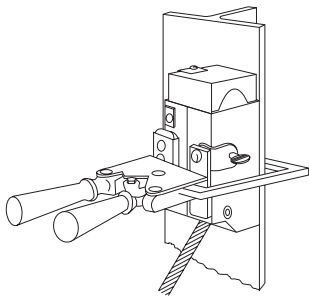

VERTICAL SURFACE MOULD SUPPORT

A Cadweld mould can be securely held to a vertical "H" column or angle by using the Vertical Surface Mould Support. It is easily attached to an existing L159 or L160 Handle Clamp. For use with Types VB, VG, VN, and VS moulds, fits steel up to 1" thick, for Type VF mould, 3/4" thick.

B134: For use with L160 E-Z CHANGE Handle Clamp

B135: For use with L159 E-Z CHANGE Handle Clamp

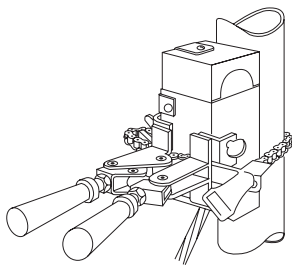

CHAIN SUPPORT HANDLE CLAMPS

A Cadweld mould can be securely held to a pipe using the clamp assembly consisting of a modified L159 or L160 Handle Clamp with built-in pipe attachment.

Clamp Part No.	Fits Mould Price	For Following Connection Types	Pipe
B159V	D & F	VS,VF,VB, & VV	Vertical
B160V	C & R	VS,VF,VB, & VV	Vertical
B159VT	D & F	VT	Vertical
B160VT	C & R	VT	Vertical
B159H	D & F	HA,HS,HC, & HT	Horizontal
B160H	C & R	HA,HS,HC, & HT	Horizontal

The above clamps are equipped with 500 mm length of chain which will fit up to 100 mm pipes. Extra 500 mm length of chain, B158, is available to fit up to 250 mm pipes.

Material, Tools and Accessories

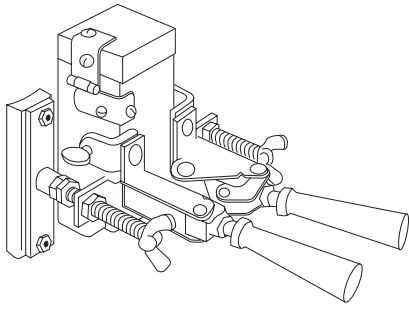

MAGNETIC HANDLE CLAMPS

A Cadweld mould can be securely held to a large flat or slightly curved vertical surface using the Handle Clamp with Magnetic Support. Used on vertically split moulds.

Clamp Part No.	Fits Mould Price Key	Minimum Width Required*
B396	C & R Price Key	8"
B159M	D & F Price Key	10-1/2"
B399AM	T Price Key	6"
B399BM	P & N Price Key	7"

*Width will vary slightly depending upon the type of connection being made.

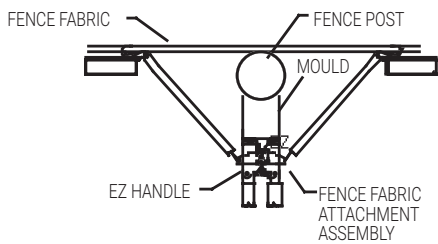

FENCE FABRIC ATTACHMENT ASSEMBLY

An easy to use, labor saving, Fence Fabric Attachment Assembly fastens to your existing L159 or L160 Handle Clamp to firmly hold your mould to the fence post after the fence fabric has been attached. Ideal for retrofit jobs.

Fence Fabric Attachment Part No.	Fits Handles
B827A	L160, L159

Material, Tools and Accessories

GROUND ROD SPECIALTY TOOLS



ERICO GROUND ROD DRIVERS

Product #	Description
EGRD58	5' Driver body with insert for up to 5/8" ground rods
EGRD58I*	Replacement insert for 5/8" ground rods
EGRD34	5' Driver body with insert for up to 3/4" ground rods
EGRD34I*	Replacement insert for 3/4" ground rods

*Both 5/8" and 3/4" inserts fit standard body of EGRD58 or EGRD34.

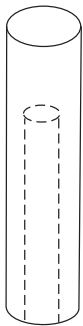

GROUND ROD DRIVING SLEEVES**

Use a Cadweld ground rod driving sleeve to prevent mushrooming top of ground rod.

Ground Rod Size	Part No.
1/2" Copper Bonded or Steel Rod	B137-14
5/8" Copper Bonded (.563" diameter)	B137-16
5/8" Steel (.625" diameter)	B137-31
3/4" Copper Bonded (.682" diameter)	B137-18
3/4" Steel (.750" diameter)	B137-33
1" Copper Bonded (.914" diameter)	B137-22
1" Steel (1.00" diameter)	B137-37

** For plain (unthreaded) ground rods only.

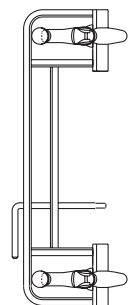

B120

GROUND ROD SPLICE CLAMP

The B120 Ground Rod Splice Clamp must be used to support the upper rod and provide a method of correctly positioning the rods and mould while splicing the rods. (Type HDGB and GB Connection).

OTHER TOOLS

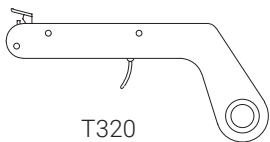

T320

FLINT IGNITORS

T320 Cadweld Flint Ignitors are used to ignite the starting material when making a Cadweld Connection. An ignitor is included with each Handle Clamp or frame. T320A Replacement Flints are also available.

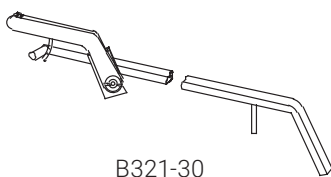

B321-30

FLINT IGNITOR EXTENSION

B321-30 Flint Ignitor Extension attaches to the T320 Flint Ignitor and allows the installer to be about 30" from the mould. Ideal for such operations where the mould is in a narrow trench and the installer is at ground level.

Material, Tools and Accessories

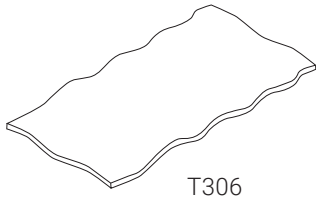

CERAMIC BLANKET

The woven Ceramic Blanket (Part T306) can be used to hold a hot mould or keep the work surface free of slag when cleaning the mould.

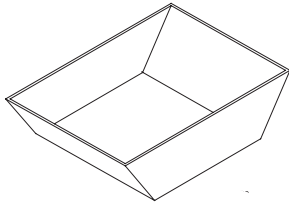
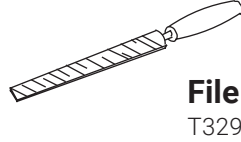

WELDING TRAY

The Welding Tray (Part No. XLB974-B2) can contain a spill of molten welding material. It is for personnel safety. Recommended when working overhead or over expensive equipment.

TOOL KITS

TOOL BOX T396

A tool box is highly recommended to carry tools, moulds, welding material and a propane torch.

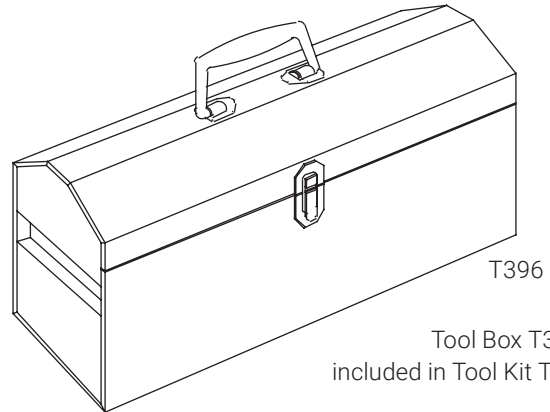

Tool Box T396 is included in Tool Kit T315A

TOOL KIT T315A

Other Tool Kits can be made for your particular requirements.

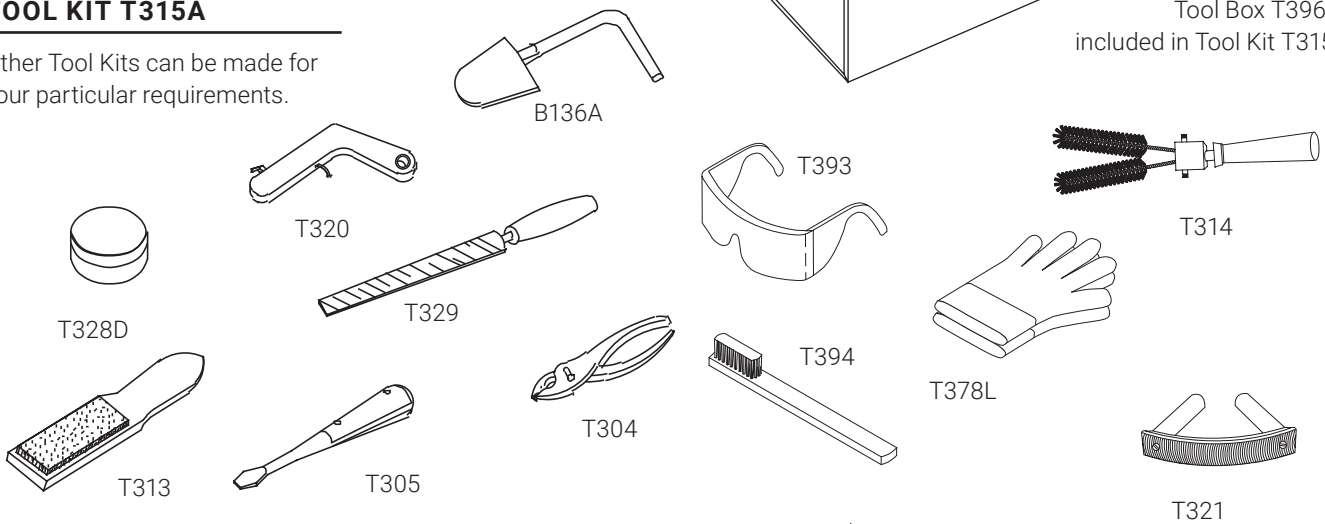

TOOL TRAY

TOOL TRAY ONLY: T331

Ideal for carrying one or two moulds, welding material, propane torch and tools.

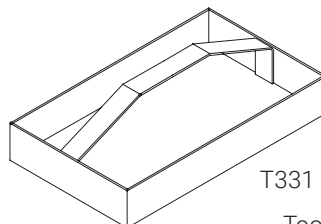

Tool Tray T331 is not included in Tool Kit T315A

Our powerful portfolio of brands:

CADDY ERICO HOFFMAN RAYCHEM SCHROFF TRACER



nVent.com/ERICO

WARNING: nVent products shall be installed and used only as indicated in nVent's product instruction sheets and training materials. Instruction sheets are available at nVent.com/ERICO and from your nVent customer service representative. Improper installation, misuse, misapplication or other failure to completely follow nVent's instructions and warnings may cause product malfunction, property damage, serious bodily injury and/or death, and void your warranty.

©2018 nVent. All nVent marks and logos are owned or licensed by nVent Services GmbH or its affiliates. All other trademarks are the property of their respective owners. nVent reserves the right to change specifications without notice.

ERICO-CAT-E524C-E891CT09ASEN-EN-1805